

SPARE PARTS CATALOGUE

Revision 060917

Spare Parts • Spare Parts • Spare Parts

Working element (Resectoscope)



<p>angular distal end</p>	Tube	NP 0/3AA
<p>straight distal end</p>	Tube	NP 0/3AB
<p>straight distal end</p>	Tube	NP 0/3AC
	Tube-set	NP 0/3B
	Tube	NP 0/3BA
<p>angular distal end</p>	Tube	NP 0/3C
<p>straight distal end</p>	Tube	NP 0/3CB
<p>straight distal end</p>	Tube	NP 0/3CC
	Tube	NP 0/3D

Working element (Resectoscope)

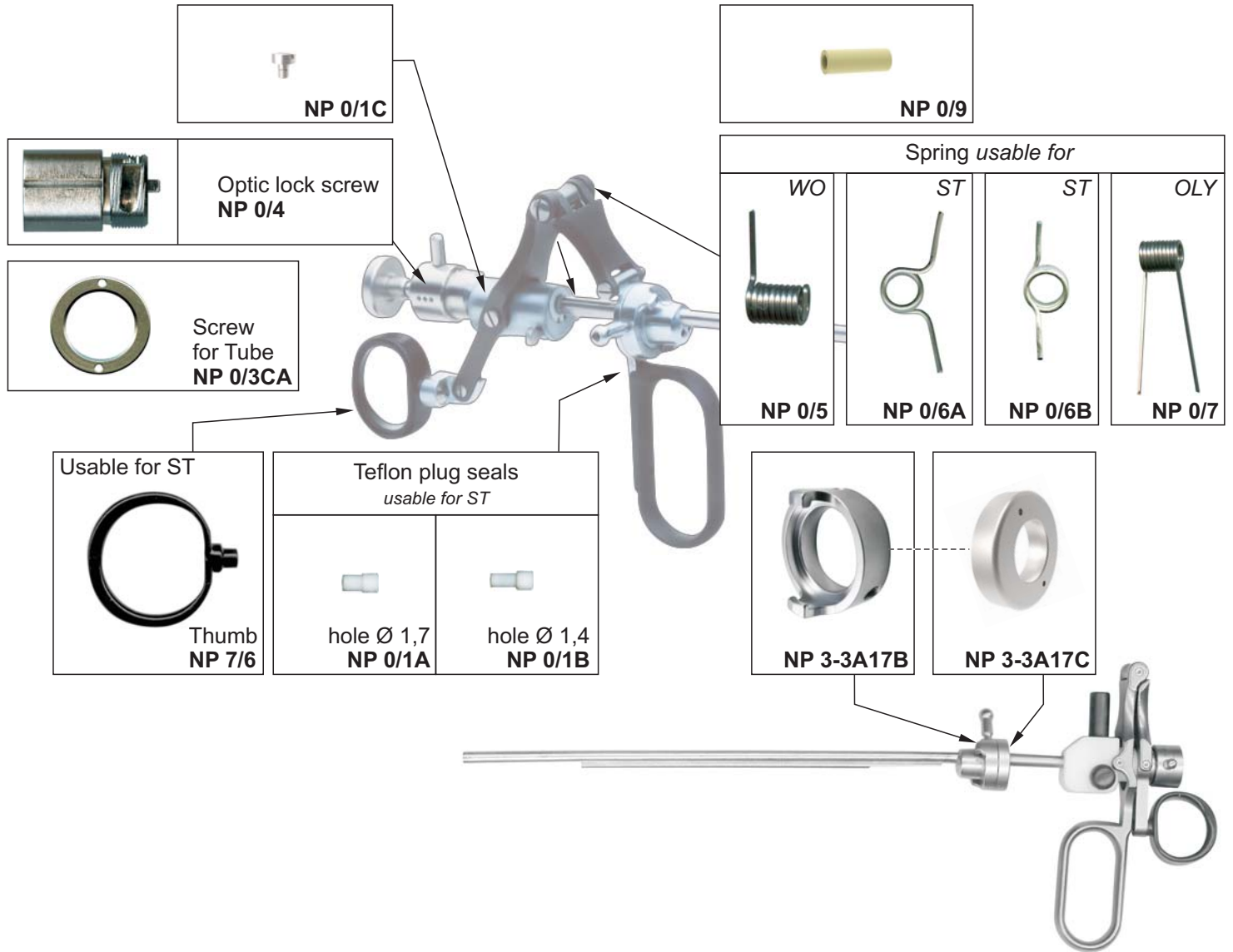









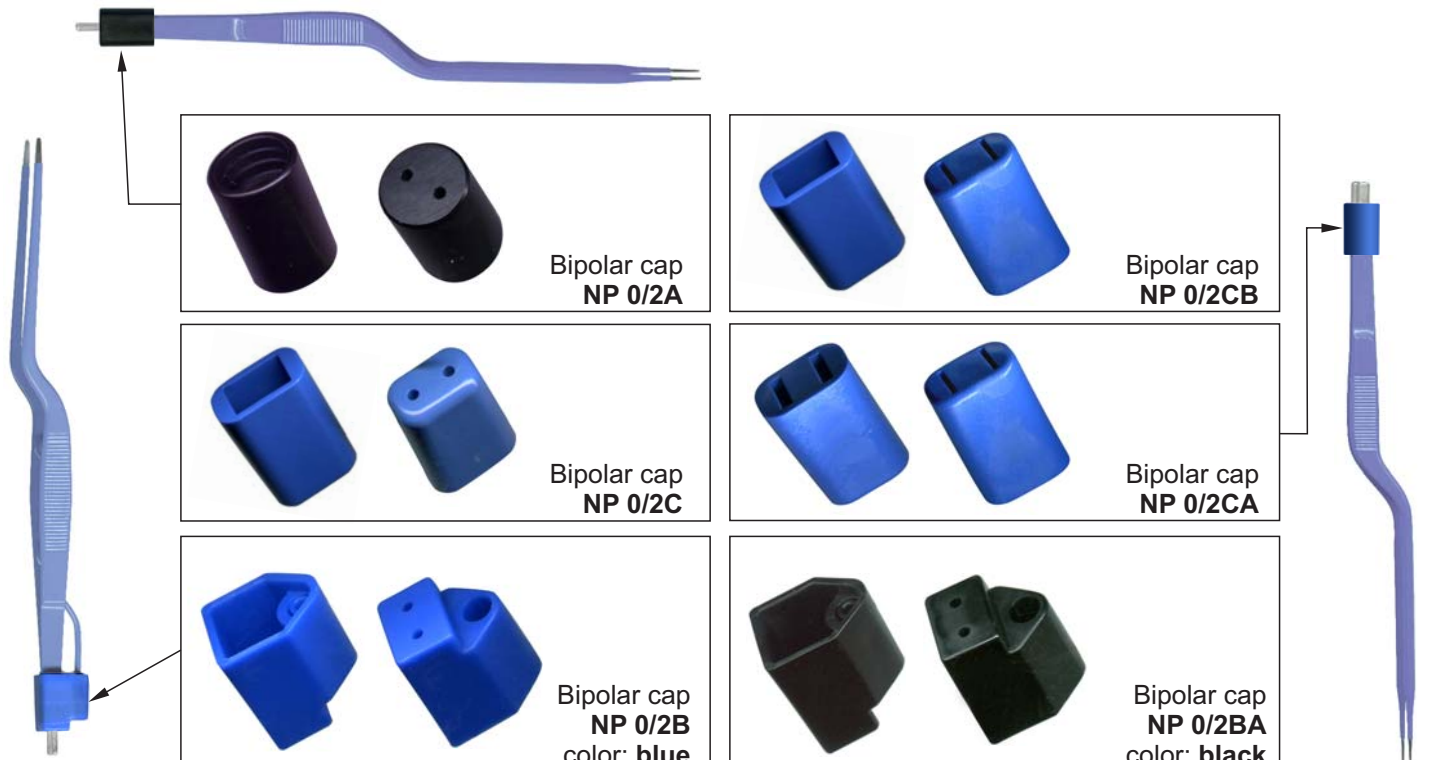



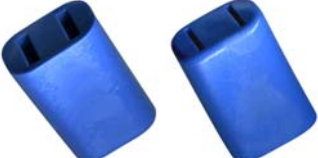

241116 NP_0-1A-2

© 2016 copyright by **DANmed**

NP 0-1A-2

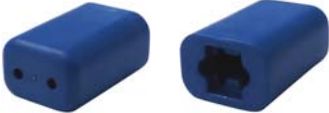
Spare Parts for Bipolar Forceps



 <p>Bipolar cap NP 0/2A</p>	 <p>Bipolar cap NP 0/2CB</p>
 <p>Bipolar cap NP 0/2C</p>	 <p>Bipolar cap NP 0/2CA</p>
 <p>Bipolar cap NP 0/2B color: blue</p>	 <p>Bipolar cap NP 0/2BA color: black</p>
 <p>Bipolar cap black NP 0/2DA blue NP 0/2DC</p>	 <p>Bipolar cap black NP 0/2EA yellow NP 0/2EB blue NP 0/2EC</p>
 <p>Bipolar cap blue NP 0/2FA</p>	 <p>Bipolar cap blue NP 0/2GA</p>
 <p>Bipolar cap black NP 0/2HA orange NP 0/2HB blue NP 0/2HC red NP 0/2HD</p>	 <p>Bipolar cap black NP 0/2JA blue NP 0/2JB blue NP 0/2JC</p>
 <p>Bipolar cap black NP 0/2KA</p>	<p>Luer</p>  <p>M4x0.5 NP 0/2LB M5 NP 0/2LA</p>

060317 NP_0-1B

Working element (Resectoscope)

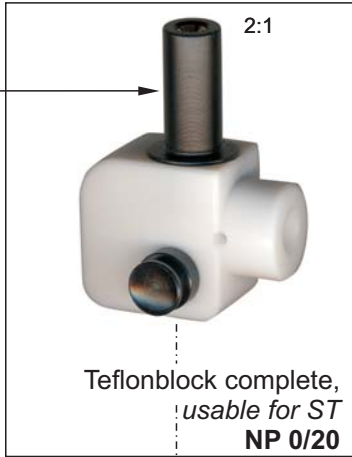
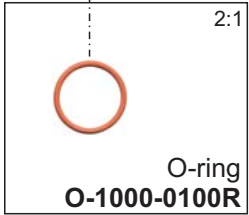
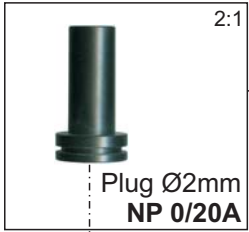

ask for cable!

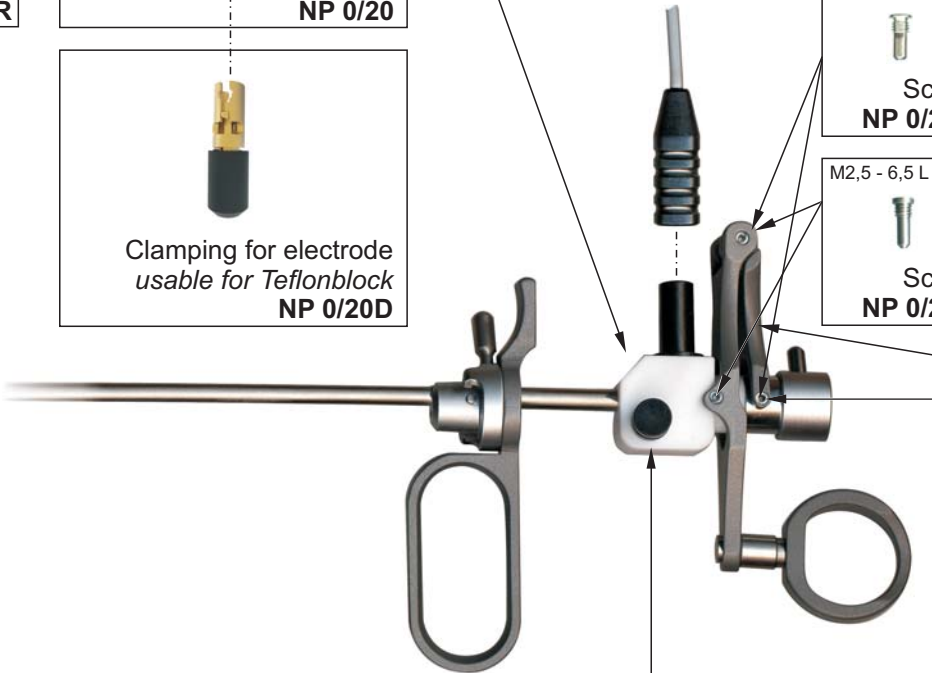
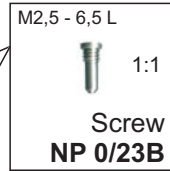
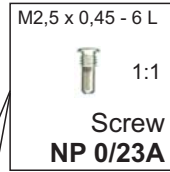

040117 NP_00-2

Usable for DAVOL

Lg.: 34 - 40,30 cm



Lg.: 13,39 inch
34 cm

Lg.: 15,16 inch
38,25 cm

Lg.: 14,76 inch
37,50 cm

Lg.: 15,87 inch
40,30 cm

Lg.: 20,47 inch
52,00 cm

NP 1/1

NP 1/2

NP 1/4

NP 1/5

NP 1/5E

Tube, usable for all length of Innerstams

Lg.: 14,25 inch / 36,2 cm

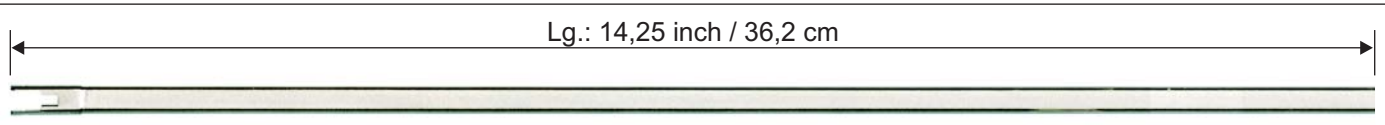

NP 1/5A

Lg.: 20,47 inch / 52,0 cm

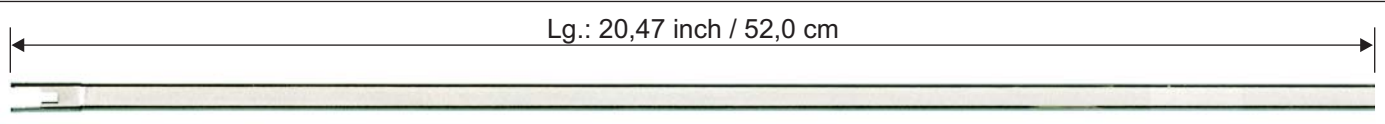

NP 1/5B

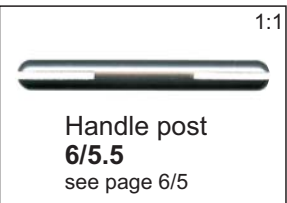
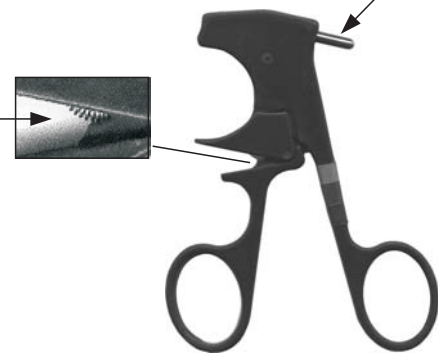
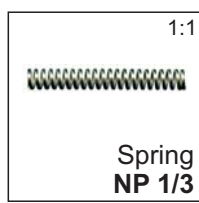
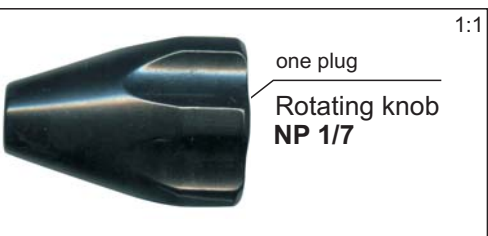
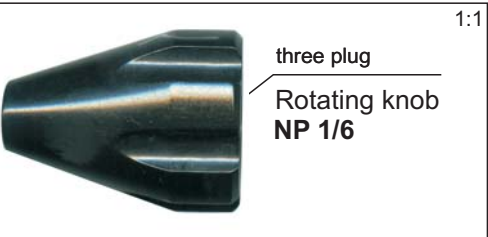
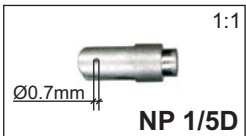
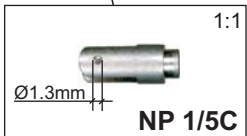

251116 NP_01_00

Usable for Arthroscopy

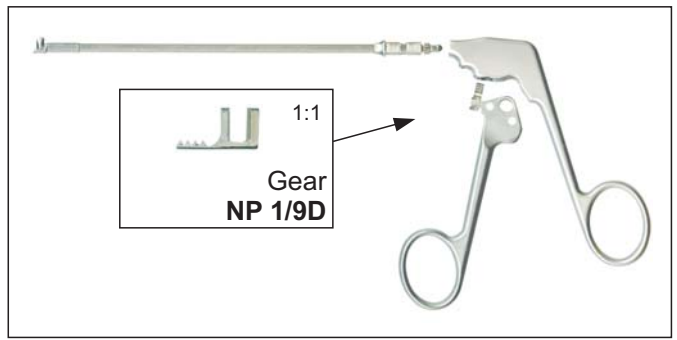
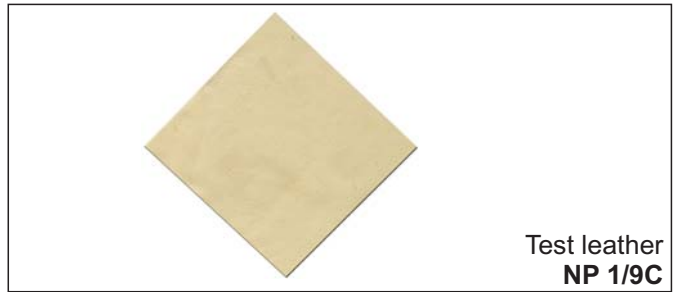
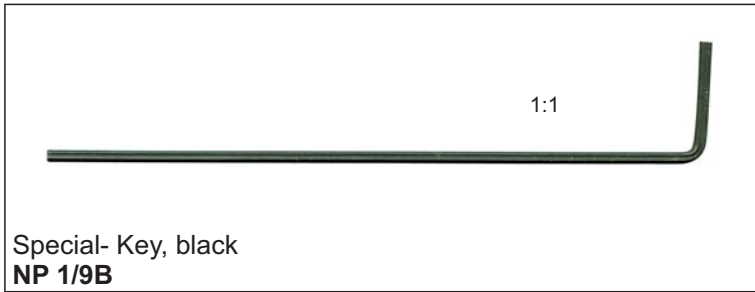
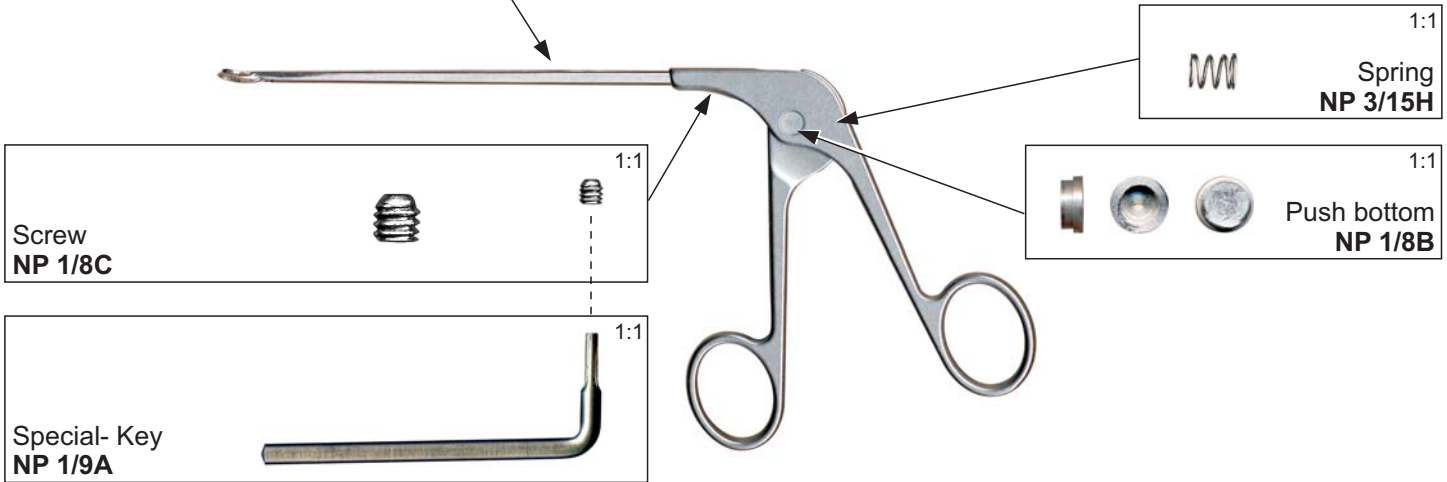
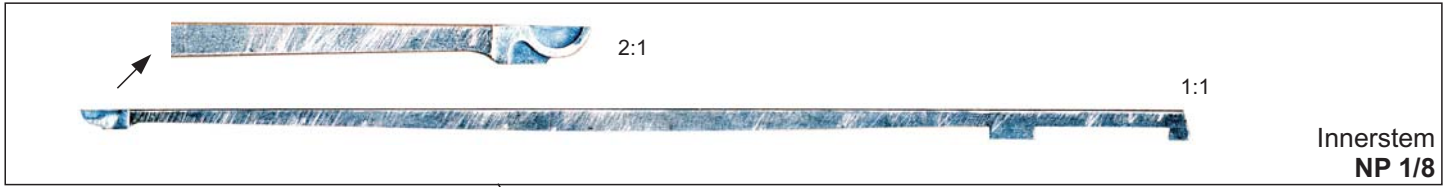

120116 NP_01_01

Usable for Arthroscopy

Types of style

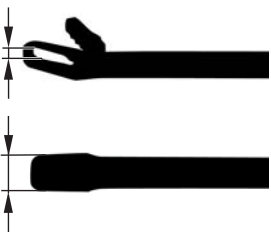

bite width
(Schnittbreite)

tip width
(Maulbreite)



straight (gerade)

upbiter (aufwärts)

upswept
(gerade, aufwärts gebogen)

upbiter right and left
(aufwärts rechts und links)

the primary style for direct approach

angled ¼ curve at tip for increased access to the posterior meniscus

angled shaft follows the contour of the condyle and keeps the cutting surface parallel to the tibial plateau

angled to reach the anterior and posterior meniscus











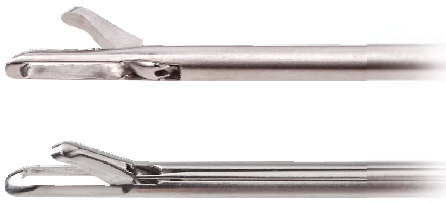

Duckbill	Description	Bite Width	Tip Width	Acufex Ref#	Order-No.
	upswept	3.17 mm	5.05 mm	012000	DAN-012000
	straight	3.17 mm	5.05 mm	012013 (7207057)	DAN-012013
	upbiter	3.17 mm	5.05 mm	012014 (7207058)	DAN-012014
	upbiter left	3.17 mm	5.05 mm	012015 (7207667)	DAN-012015
	upbiter right	3.17 mm	5.05 mm	012016 (7207664)	DAN-012016

Alligator	Description	Bite Width	Tip Width	Acufex Ref#	Order-No.
	straight		3.05 mm	011020 (7207060)	DAN-011020
	straight		3.45 mm	011024	DAN-011024







Backbiter	Description	Bite Width	Tip Width	Acufex Ref#	Order-No.
	right	2.38 mm	5.58 mm	012058 (7207054)	DAN-012058
	left	2.38 mm	5.58 mm	012059 (7207055)	DAN-012059



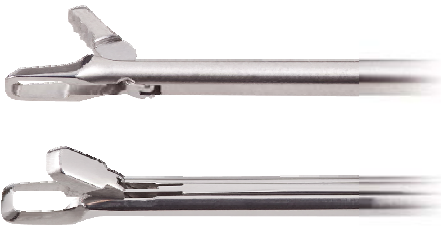



150110 NP_01_02A



Usable for Arthroscopy

Scoop	Description	Bite Width	Tip Width	Acufex Ref#	Order-No.
	 straight	1.77 mm	3.76 mm	012011	DAN-012011
	 straight	2.03 mm	3.76 mm	012012	DAN-012012
	 upbiter	1.59 mm	3.88 mm	012020	DAN-012020
	 straight	1.59 mm	3.25 mm	012029	DAN-012029
	 upbiter	1.59 mm	3.27 mm	012030	DAN-012030
	 upswept	1.59 mm	3.27 mm	012031	DAN-012031
	 downbiter	1.59 mm	3.27 mm	012033	DAN-012033
	 straight	1.59 mm	3.27 mm	012034 (7207046)	DAN-012034
	 curved left	1.59 mm	3.27 mm	012040	DAN-012040
	 curved right	1.59 mm	3.27 mm	012041	DAN-012041
	 upbiter curved left	1.59 mm	3.27 mm	012042	DAN-012042
	 upbiter curved right	1.59 mm	3.27 mm	012043	DAN-012043

Usable for Arthroscopy



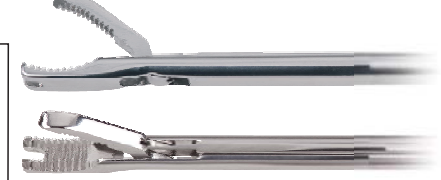

Duckling	Description	Bite Width	Tip Width	Acufex Ref#	Order-No.
	 straight	3.17 mm	5.00 mm	012044 (7207049)	DAN-012044
	 upbiter	3.17 mm	5.00 mm	012045 (7207000)	DAN-012045
	 curved left	3.17 mm	5.00 mm	012046 (7207050)	DAN-012046
	 curved right	3.17 mm	5.00 mm	012047 (7207051)	DAN-012047
	 upswept	3.17 mm	5.00 mm	012048	DAN-012048





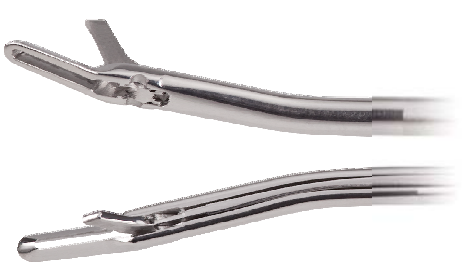

Oval Punch	Description	Bite Width	Tip Width	Acufex Ref#	Order-No.
	 upbiter	4.39 mm	6.57 mm	7207200 (7207083)	DAN-7207200
	 straight	4.39 mm	6.57 mm	7207201 (7207181)	DAN-7207201
	 curved left	4.39 mm	6.57 mm	7207294	DAN-7207294
	 curved right	4.39 mm	6.57 mm	7207295	DAN-7207295
	 upswept	4.39 mm	6.57 mm	7207296	DAN-7207296

Pitbull	Description	Bite Width	Tip Width	Acufex Ref#	Order-No.
	 straight			011022 (7207061)	DAN-011022

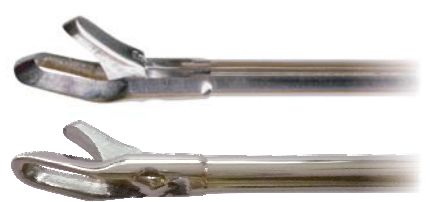
250713 NP_01_02C

Usable for Arthroscopy







Scissors Punches	Description	Bite Width	Tip Width	Acufex Ref#	Order-No.
	 straight			012036 (7207047)	DAN-012036
	 upbiter			012037 (7207048)	DAN-012037
	 curved left			012038 (7207669)	DAN-012038
	 curved right			012039 (7207670)	DAN-012039

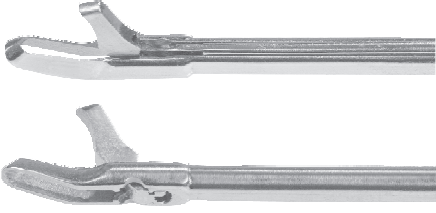

Posterior Punches	Description	Bite Width	Tip Width	Acufex Ref#	Order-No.
	 upbiter	2.18 mm	4.00 mm	012201	DAN-012201
	 upswept	2.18 mm	4.00 mm	012202	DAN-012202
	 straight	2.18 mm	4.00 mm	012203	DAN-012203
	 curved left	2.18 mm	4.00 mm	012204	DAN-012204
	 curved right	2.18 mm	4.00 mm	012205	DAN-012205



Grasping Forceps	Description	Bite Width	Tip Width	Acufex Ref#	Order-No.
	Raptor Jr.			014843	DAN-014843
	Raptor			014720	DAN-014720

250713 NP_01_02D

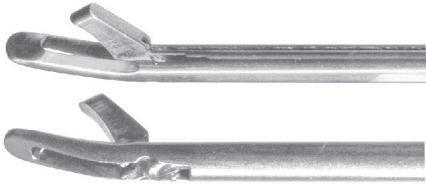
Usable for Arthroscopy

Basket Punches Narrowline	Description	Bite Width	Tip Width	Acufex Ref#	Order-No.
	 upbiter	1.67 mm	2.89 mm	012051	DAN-012051
	 straight	1.67 mm	2.89 mm	012052	DAN-012052
	 curved left	1.67 mm	2.89 mm	012053	DAN-012053
	 curved right	1.67 mm	2.89 mm	012054	DAN-012054
	 upswept	1.67 mm	2.89 mm	012055	DAN-012055

Basket Punches Meniscal Elevator	Description	Bite Width	Tip Width	Acufex Ref#	Order-No.
	 straight	2.38 mm	5.58 mm	012060	DAN-012060
	 upbiter	2.38 mm	5.58 mm	012061	DAN-012061

Basket Punches Blunt Nose	Description	Bite Width	Tip Width	Acufex Ref#	Order-No.
	 straight	1.67 mm	3.32 mm	012035	DAN-012035

Tissue Tensioner	Description	Bite Width	Tip Width	Acufex Ref#	Order-No.
	straight			011030	DAN-011030

030817 NP_01_02E

© 2017 copyright by **DANmed**

NP 1-02E

Curettes usable for Codman usable for KARLIN Lumbar Microdiscectomy Instruments

Forward Straight (FS)

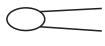
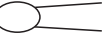
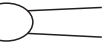

FS 0		DAN-46-3121
FS 1		DAN-46-3122
FS 2		DAN-46-3123



Forward Angled (FA)

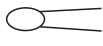
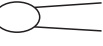
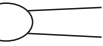

FA 0		DAN-46-3124
FA 1		DAN-46-3125
FA 2		DAN-46-3126

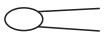

Forward Down (FD)



FD 0		DAN-46-3127
FD 1		DAN-46-3128
FD 2		DAN-46-3129

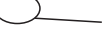

Backward Straight (BS)



BS 0		DAN-46-3130
BS 1		DAN-46-3131
BS 2		DAN-46-3132

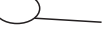

Backward Angled (BA)



BA 0		DAN-46-3133
BA 1		DAN-46-3134
BA 2		DAN-46-3135

Backward Down (BD)

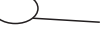





BD 0		DAN-46-3136
BD 1		DAN-46-3137
BD 2		DAN-46-3138

usable for KARLIN Cervical Microdiscectomy Instruments





Forward Straight (FS)



FS 0		DAN-46-3151
FS 00		DAN-46-3152
FS 000		DAN-46-3153
FS 0000		DAN-46-3154

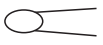

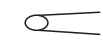

Forward Angled (FA)



FS 0		DAN-46-3156
FS 00		DAN-46-3157
FS 000		DAN-46-3158
FS 0000		DAN-46-3159



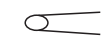

Backward Straight (BS)



FS 0		DAN-46-3161
FS 00		DAN-46-3162
FS 000		DAN-46-3163
FS 0000		DAN-46-3164

Backward Angled (BA)



FS 0		DAN-46-3166
FS 00		DAN-46-3167
FS 000		DAN-46-3168
FS 0000		DAN-46-3169



2-56UNC x Ø3.2 - 6.2 L
6/7BJ

080416 NP 1-03

Cholangiogram Clamp

Jaw + Tube
NP 1/11A

Lg.: 400 mm
Lg.: 15.74 inch

Jaw + Tube
NP 1/11B

Lg.: 338 mm
Lg.: 13.30 inch

End nut thread M3x0,5 NP 1/13	End nut thread M3x0,35 NP 1/14	Block for Choli NP 1/15

Jaw + Tube
usable for ST
NP 1/11C

Lg.: 315 mm
Lg.: 12.40 inch

NP 1/19	End tube NP 1/17

Repair exchange
NP 1/16

Ratchet
NP 1/18

Handle
NP 1/10A

Jaw + Tube + Handle complete

LCG-001-400	WL = 400mm
LCG-001-338	WL = 338mm
LCG-001-315	WL = 315mm

Handle
NP 1/10B

141015 NP_01_10

Rotating Knob



1:1

Index
NP 1/20A

Cap alone
NP 1/20G 1:1



Knob complete
NP 1/20B

Cap alone
NP 1/20H 1:1



Knob complete
NP 1/20C

Cap alone
NP 1/20I 1:1



Knob complete
NP 1/20D

Cap alone
NP 1/20J 1:1



Knob complete
NP 1/20E

Cap alone
NP 1/20K 1:1



Knob complete
NP 1/20F



1:1

Clean out / plastic
NP 1/20L



1:1

Cap
NP 1/20M



Cap
NP 1/20N



1:1

Cap
NP 1/20Y



1:1

Cap
NP 1/20R



1:1

Cap
NP 1/20S

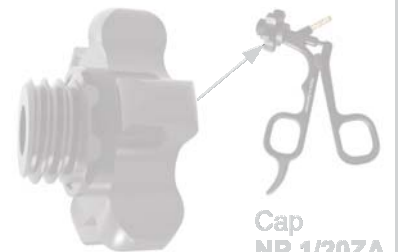

Cap
NP 1/20ZA

180216 NP_01_20A

Usable for JARIT

Cap NP 1/20QA 1:1

Cap NP 1/20Q 1:1

NP 1/20U

Screw NP 1/20UB

Cap NP 1/20P 1:1

Index NP 1/20PA 1:1

Push button with description NP 1/20UA

Steel Tube with thread

1:1

NP 1/20PB

Steel Tube w. thread - insulated

1:1

NP 1/20PC

Cap NP 1/20Q 1:1

NP 5/27K

NP 1/20W 1:1

Lock for handle NP 1/20T 1:1

NP 1/20XA 1:1



6/5.10 1:1

NP 1/20XB

241014 NP_01_20B

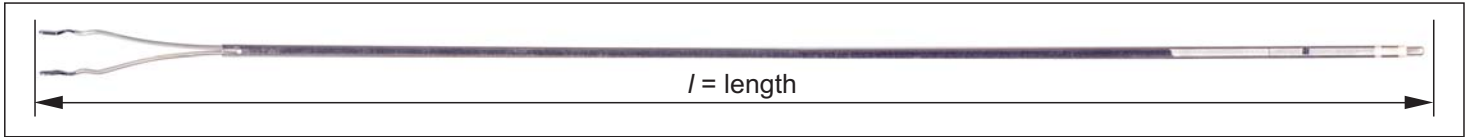
Bipolar Tube Coagulation Forceps

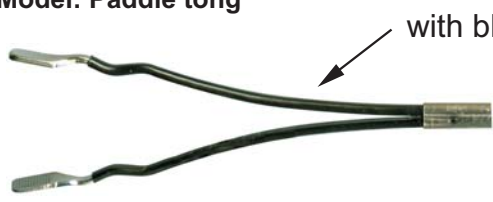

	<i>usable ST</i>	<i>usable WO</i>
Model: Wave 	Insert wave complete short version, WL 330 mm <i>l</i> = 421 mm NP 2/1A	Insert wave complete short version, WL 300 mm <i>l</i> = 421 mm NP 2/3C
	Insert wave complete long version, WL 430 mm <i>l</i> = 527 mm NP 2/2A	Insert wave complete long version, WL 450 mm <i>l</i> = 527 mm NP 2/4C
	Insert complete short version, WL 330 mm <i>l</i> = 421 mm NP 2/1B	Insert complete short version, WL 300 mm <i>l</i> = 421 mm NP 2/3B
	Insert complete long version, WL 430 mm <i>l</i> = 532 mm NP 2/2B	Insert complete long version, WL 450 mm <i>l</i> = 532 mm NP 2/4B
Model: Paddle tong 	Insert paddle tong complete short version, WL 330 mm <i>l</i> = 418 mm NP 2/1C	Insert paddle tong complete short version, WL 300 mm <i>l</i> = 418 mm NP 2/3A
	Insert paddle tong complete long version, WL 430 mm <i>l</i> = 543 mm NP 2/2C	Insert paddle tong complete long version, WL 450 mm <i>l</i> = 543 mm NP 2/4A
Model: Paddle tong  <p style="text-align: center;">with black insulation</p>		Insert paddle tong complete short version, WL 300 mm <i>l</i> = 418 mm, BLACK NP 2/3AB
		Insert paddle tong complete long version, WL 450 mm <i>l</i> = 543 mm, BLACK NP 2/4AB

Outer Tube for ST- Bipolar Forceps



short version, WL 330 mm **NP 2/16A**

long version, WL 430 mm **NP 2/16B**

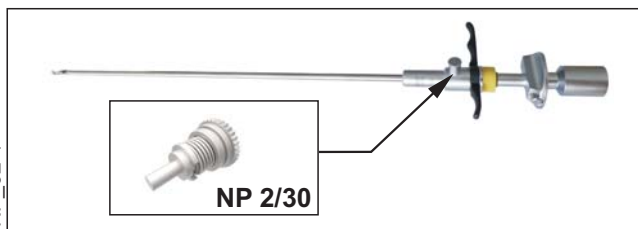

250615 NP_02-1

Repair Kits for Bipolar Tube Coagulation Forceps

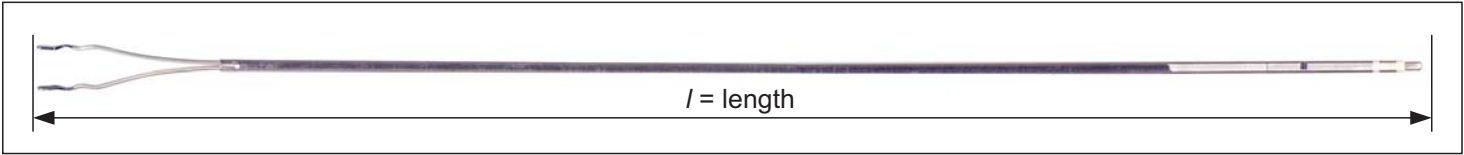

Usable ST

Repair-Kit complete, usable for ST
Adapter + Tube + Insulation + Wire

Insert wave Repair-Kit,
short version, WL 330 mm
l = 421 mm **NP 2/1**

Insert wave Repair-Kit,
long version, WL 430 mm
l = 527 mm **NP 2/2**

Wave



Adapter, usable for ST



with thread
NP 2/8A

Tube, usable for ST



Adapter, usable for ST



with thread
NP 2/8B

Insulation *l* = 10 cm
black **NP 2/11** clear **NP 2/12**



Wire
per 3 feet/1 m
NP 2/5



Usable WO

Repair-Kit complete, usable for WO
Adapter + Tube + Insulation + Wire

Insert paddle tong Repair-Kit,
short version, WL 300 mm
l = 418 mm **NP 2/3**

Insert paddle tong Repair-Kit,
long version, WL 450 mm
l = 543 mm **NP 2/4**

Paddle tong



Adapter, usable for WO



with thread
NP 2/9

Tube, usable for WO



Insulation *l* = 10 cm
black **NP 2/11** clear **NP 2/12**



Wire
per 3 feet/1 m
NP 2/5



Spare Parts usable for Bipolar Coagulation Forceps



Handle
NP 2/20

Tube assembly



short version, WL 310 mm
NP 2/22A

long version, WL 440 mm
NP 2/22B

Type thumb ring handle



short version, Ø5mm, WL 320 mm
NP 2/23A

long version, Ø5mm, WL 450 mm
NP 2/23B

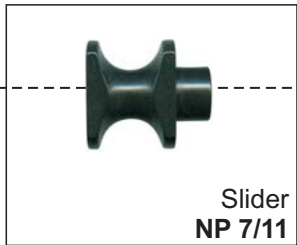

Slider
NP 7/11

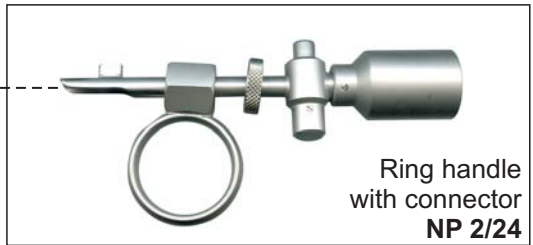

Ring handle
with connector
NP 2/24

150311 NP_02-2B

Light post adapter

usable for ST, OLY, WO
STRYKER, ACMI...

Light post adapter
usable for WO



NP 3/0A

Attachment Ø 9mm
usable for WO



NP 3/0B

Attachment
usable for
ST, OLY



NP 3/0C

Attachment
usable for
ACMI



NP 3/0CA

Attachment
usable for
STRYKER



NP 3/0CB

Fix light post



NP 3/0E

Fiber bundle
head adapter

NP 3/0G-(x)

see price list f. Ø



Cosmetic ring

see price list f. colour
+ dimension

Cosmetic ring

see price list f. colour
+ dimension



Eyepiece

usable for ST
(see also page NP 9)

Eyepiece adapter
usable for ST



NP 9/6

Eyepiece
usable for ST



Radel
NP 9/8A

Eyepiece adapter
usable for ST



NP 9/7

Eyepiece
usable for ST



Radel
NP 9/8B

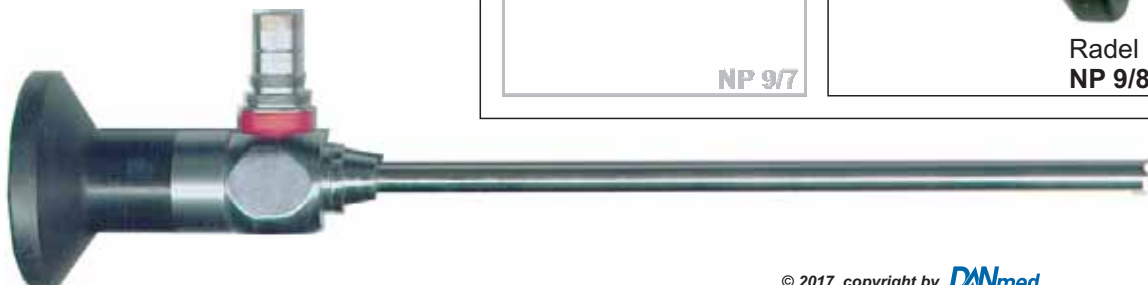

030817 NP_03_0A

© 2017 copyright by **DANmed**

NP 3-0A

Fiberglass light carriers for Laryngoscopes

Fiberglass light carriers SMALL



incl. all adapters usable for ACMI WOLF STORZ

NP 3/0B-03

Fiberglass light carriers MEDIUM



incl. all adapters usable for ACMI WOLF STORZ

NP 3/0B-04

Fiberglass light carriers LARGE



incl. all adapters usable for ACMI WOLF STORZ

NP 3/0B-05

Suction tube



NP 3/0B-06

Injection cannula



NP 3/0B-07

301112 NP_03_0B

Compatible parts for Weck handle

Rotating knob

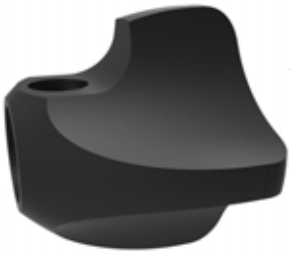

1:1

- NP 3/8A
- NP 3/8B
- NP 3/8DA

Rotating cap



with stainl. steel insert

1:1

- NP 3/8F
- NP 3/8E
- NP 3/8H

1:1



Flush port
NP 3/8C

1:1

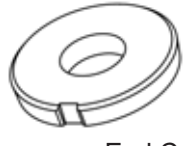

End Cap
NP 3/8BB

1:1



End cap
NP 3/8BC

1:1



End Cap
NP 3/8BD

1:1



End Cap
NP 3/8BE

1:1



Rotating knob
NP 3/8G

Index Tubing Ø4,0 mm



1:1

NP 3/3A

Index Tubing Ø4,8 mm

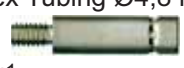

1:1

NP 3/3B

Rotating Knob complete



1:1

NP 3/8

1:1



Clean Out
NP 3/2

1:1



Ball Ø3mm
NP 3/5

1:1



Spring
NP 3/4

1:1



Post
6/5.6

1:1



Post
6/5.7

1:1



Screw
6/7 AR

2:1



Seal plug
NP 3-1A3B

2:1



Seal plug
NP 3-1A3C

1:1



1/52

1:1



O-0150-0100R

1:2

Complete shaft
NP 3-1A3A

190517 NP_03_1A

Spare parts usable for Slide Lock Handle

Forceps Jaw Tip-assembly, single-action
complete on shaft with drive rod and insulation



Forceps Jaw Tip-assembly, single-action
complete on shaft with drive rod and insulation

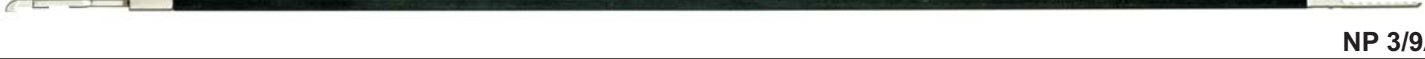

Forceps Jaw Tip-assembly, double-action
complete on shaft with insulation without drive rod

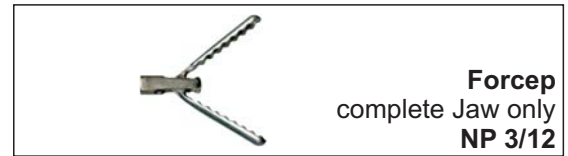
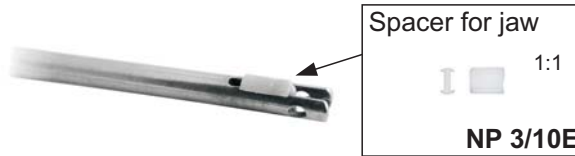

Drive Rod for rotatable double-action Tip-Assembly



Connector for rotatable double-action Tip-Assembly

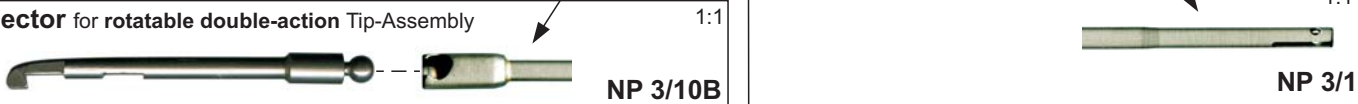

Drive Rod for double-action Tip-Assembly



Tip-Assembly with drive Rod, double-action



Tip-Assembly, single-action



Tip-Assembly, double-action



270916 NP_03_1B

Spare parts usable for Slide Lock Handle

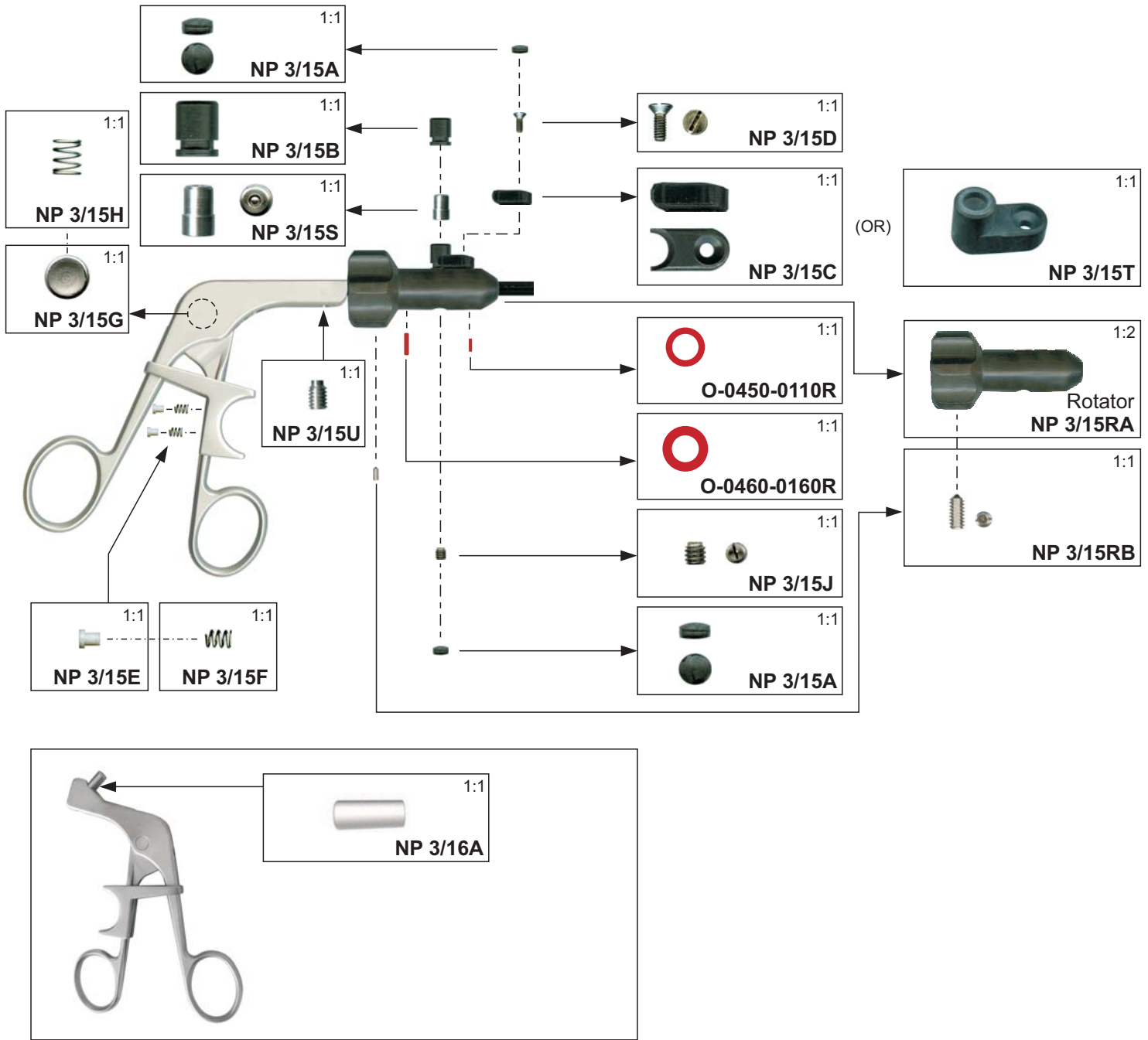

071215 NP_03_1C

Compatible parts usable for Ethicon



Complete Needle Holder Insert for exchange

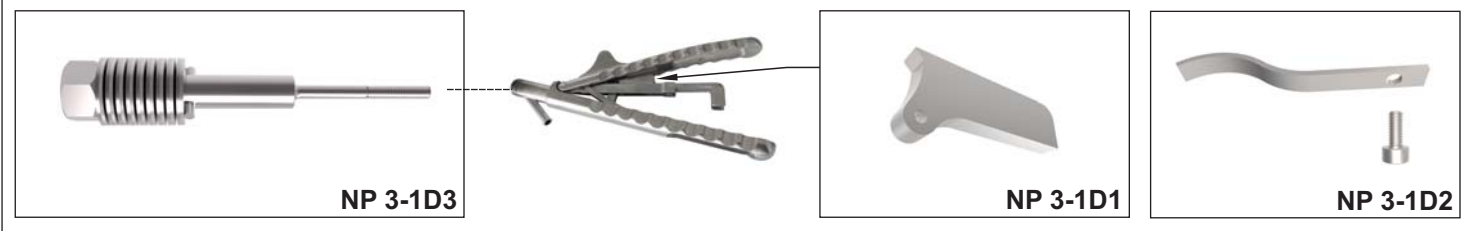
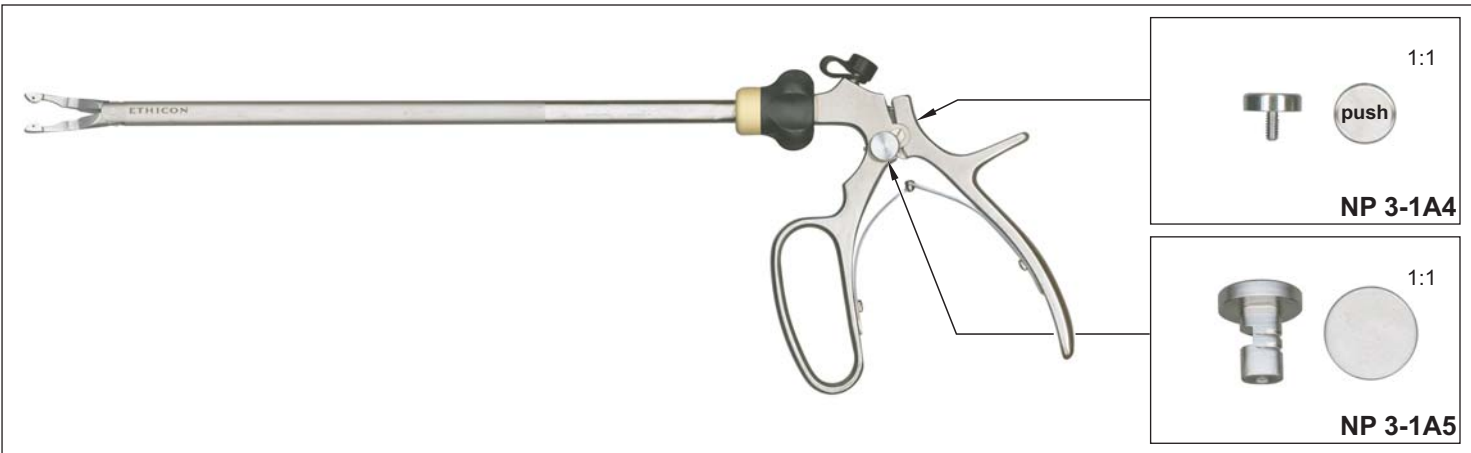

Compatible parts usable for Davis + Geck

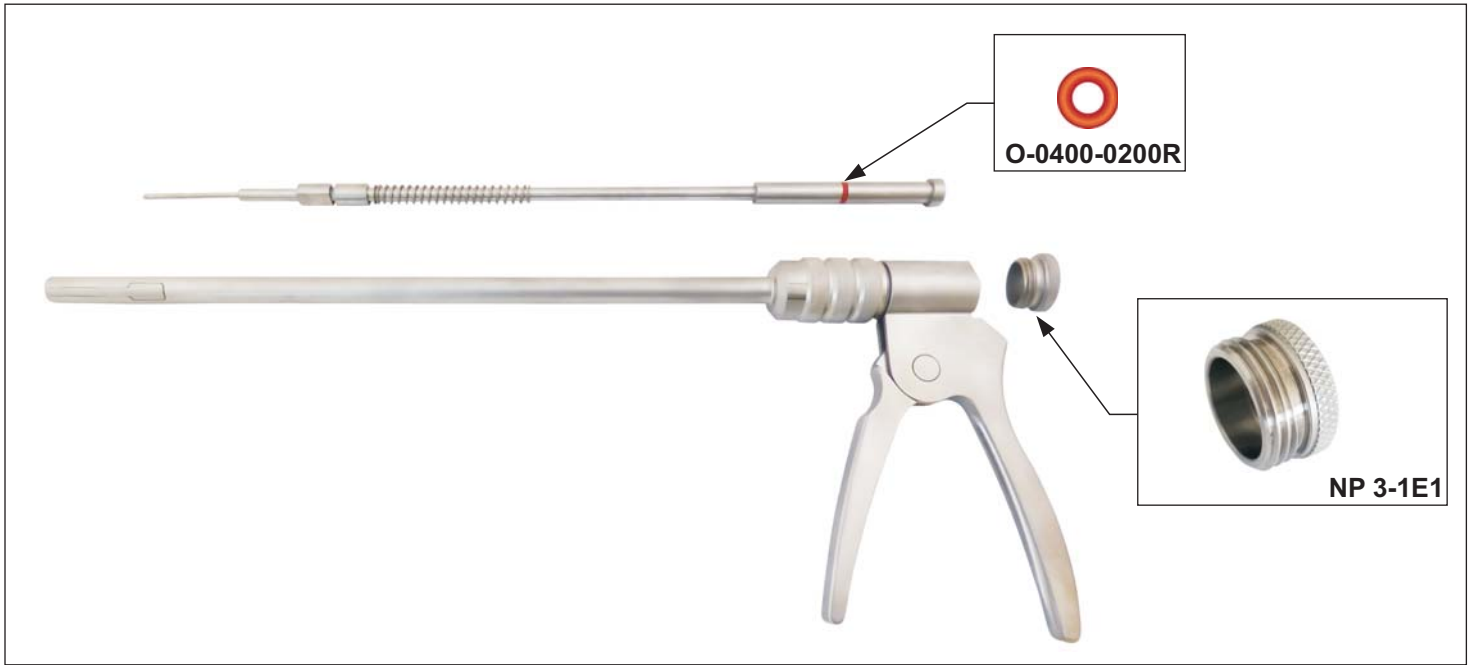

Spacer for rigid Scopes

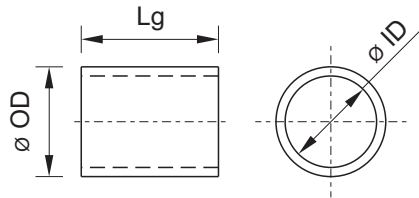
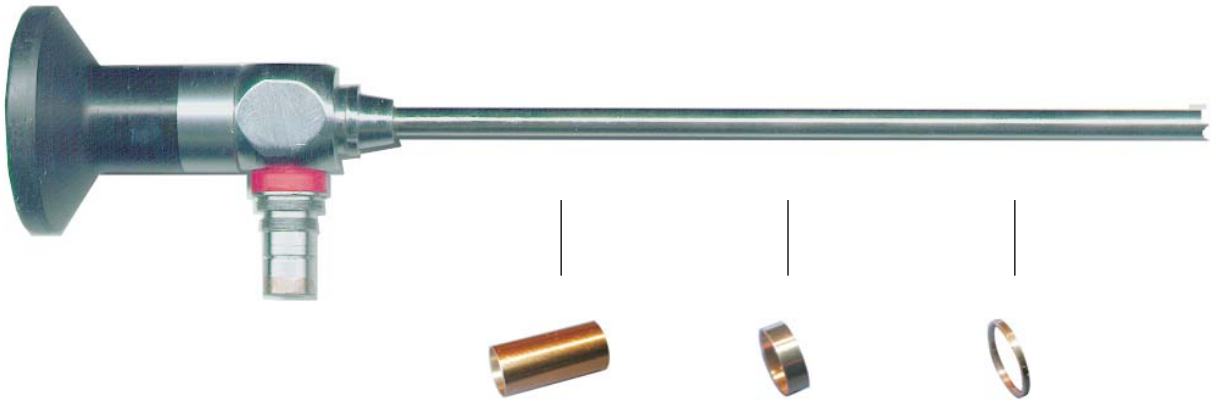

We are able to manufacture all sizes

Shaft replacements

	Steel Tubing Ø4,8 mm	Steel Tubing with insulation Ø4,5 mm	Steel Tubing w/o insulation Ø4,5 mm
M 4 x 0,25 283 mm / 11.1 inch length 1:4	NP 3-3A30	NP 3-3A40	
M 4 x 0,25 343 mm / 13.5 inch length 1:4	NP 3-3A31	NP 3-3A41	
M 4 x 0,25 413 mm / 16.2 inch length 1:4	NP 3-3A32	NP 3-3A42	
M 4 x 0,50 343 mm / 13.5 inch length 1:4	NP 3-3A6	NP 3-3A7	NP 3-3A7X
M 4 x 0,50 413 mm / 16.2 inch length 1:4	NP 3-3A62	NP 3-3A72	

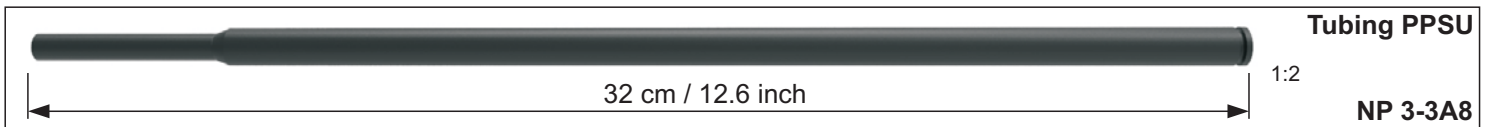
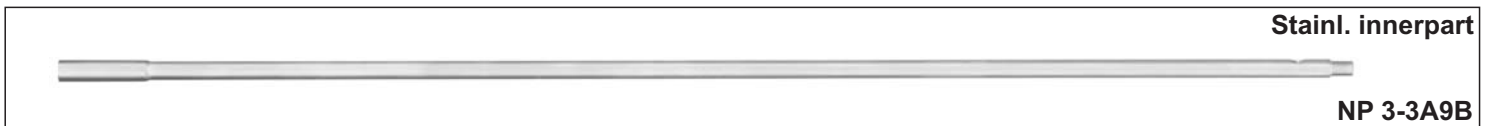
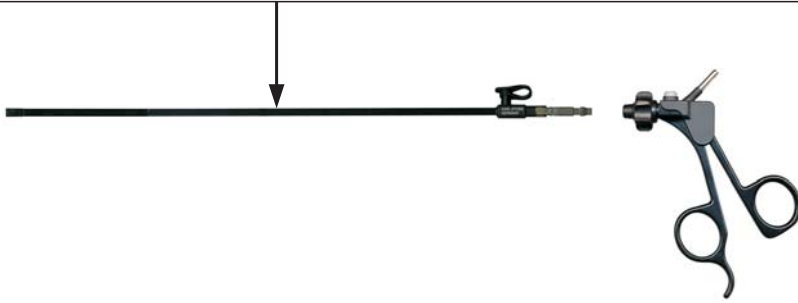

100415 NP_03_3A-1

Shaft replacements

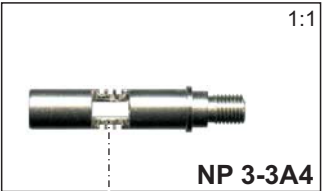
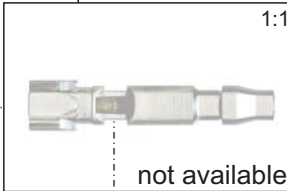
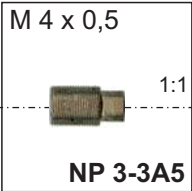
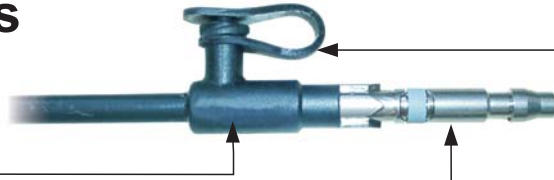

(OR)

(OR)

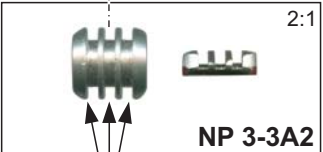
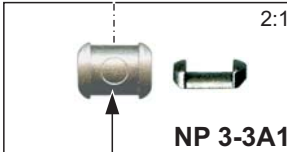

260716 NP_03_3A-2

Handle replacements

Outer Tube, Ø5 mm, length 36 cm

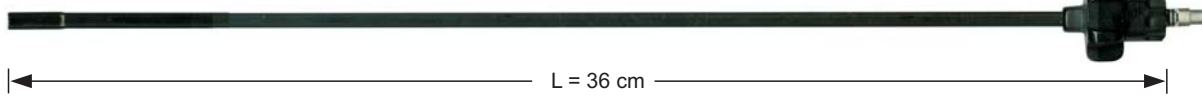

NP 3-3C2

Outer Tube, Ø5 mm, length 43 cm

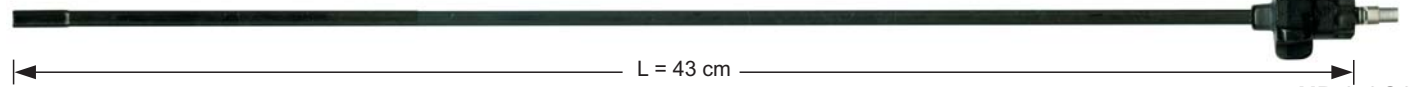

NP 3-3C3

Outer Tube, Ø10 mm, length 36 cm



NP 3-3C4

Outer Tube, Ø10 mm, length 43 cm

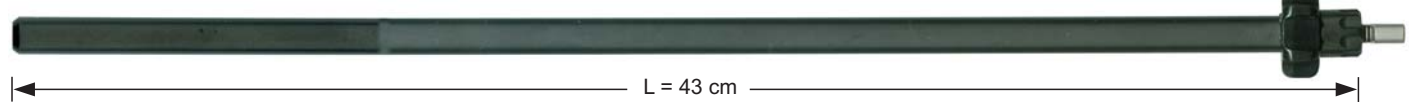

NP 3-3C5

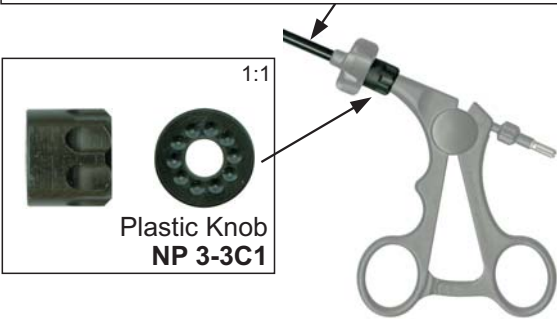

Plastic Knob
NP 3-3C1



Seal Cap
NP 3-3B2



Outer Housing
NP 3-3B4

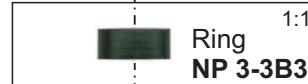

Ring
NP 3-3B3



Inner Housing
NP 3-3B5



Spring
NP 3-3B6



NP 3-3L5

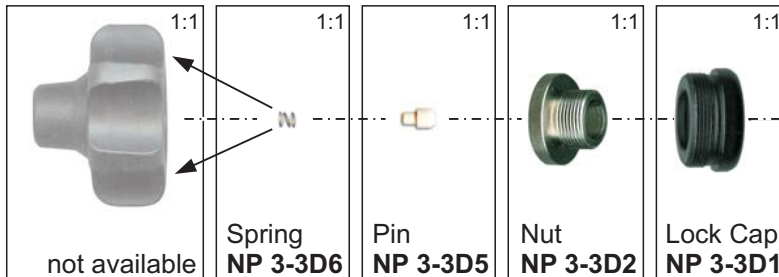

not available

Spring
NP 3-3D6

Pin
NP 3-3D5

Nut
NP 3-3D2

Lock Cap
NP 3-3D1



Handle Cover
NP 3-3D3

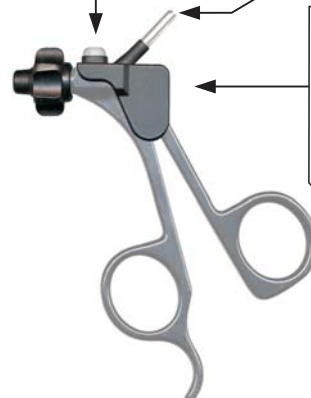

270916 NP_03_3B

Handle replacements

Screw Set NP 3-3F2 (1:1)

Standard size Variant 1

Handle post NP 3-3G1 (1:1)

Pin NP 3-3G4 (1:1)

Improved repair set Variant 2

Handle post NP 3-3E1 (1:1)

Case NP 3-3E2 (1:1)

Spring NP 3-3E3 (1:1)

Pin NP 3-3E4 (1:1)

Ratchet NP 3-3F1 (1:1)

Housing NP 3-3H1 (1:1)

Endcap NP 3-3H2 (1:1)

Spring 5/6X (1:1)

Rollerspring 5/4G (1:1)

5/4HC (1:1)

5/6XA (1:1)

6/7BL (1:1)

6/7BK (1:1)

Spring 5/4HA (1:1)

Spring 5/4HB (1:1)

Spring NP 3-3S9 (1:1)

230517 NP_03_3B-2

Handle replacements

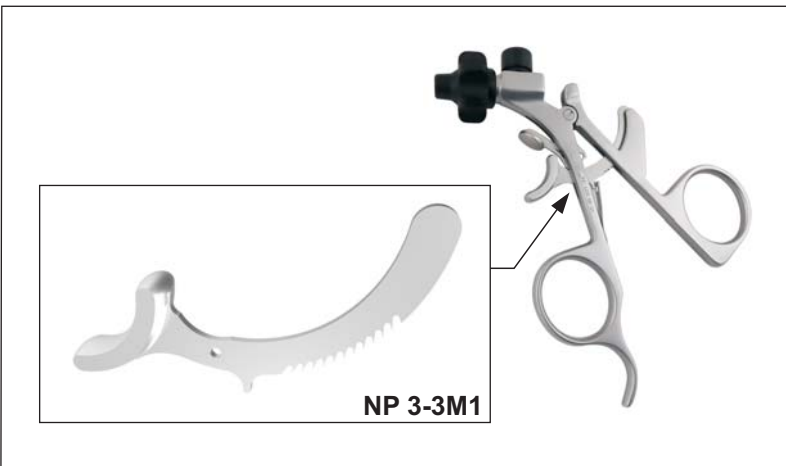
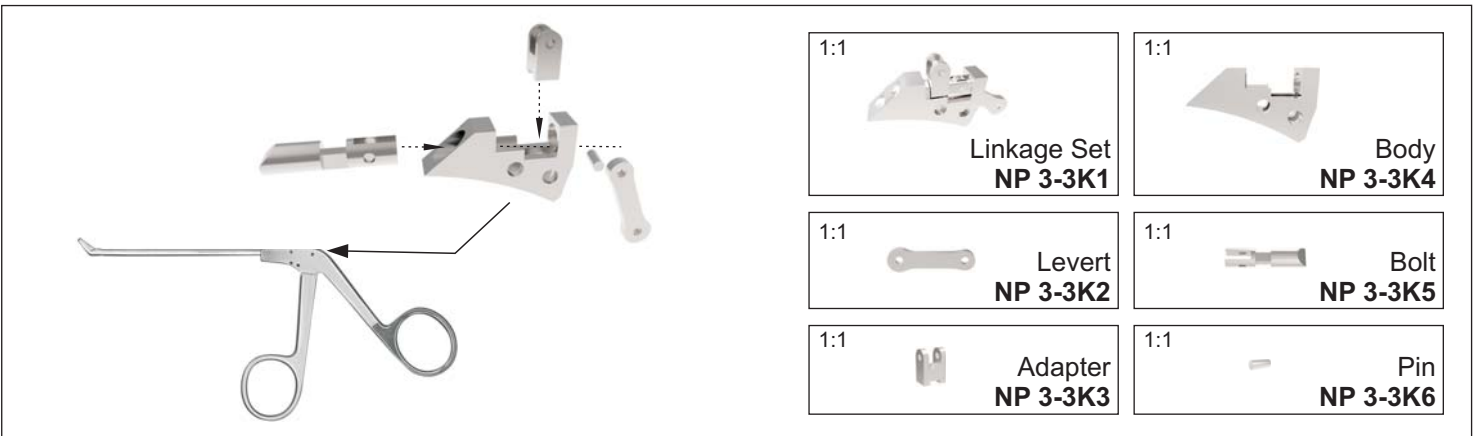
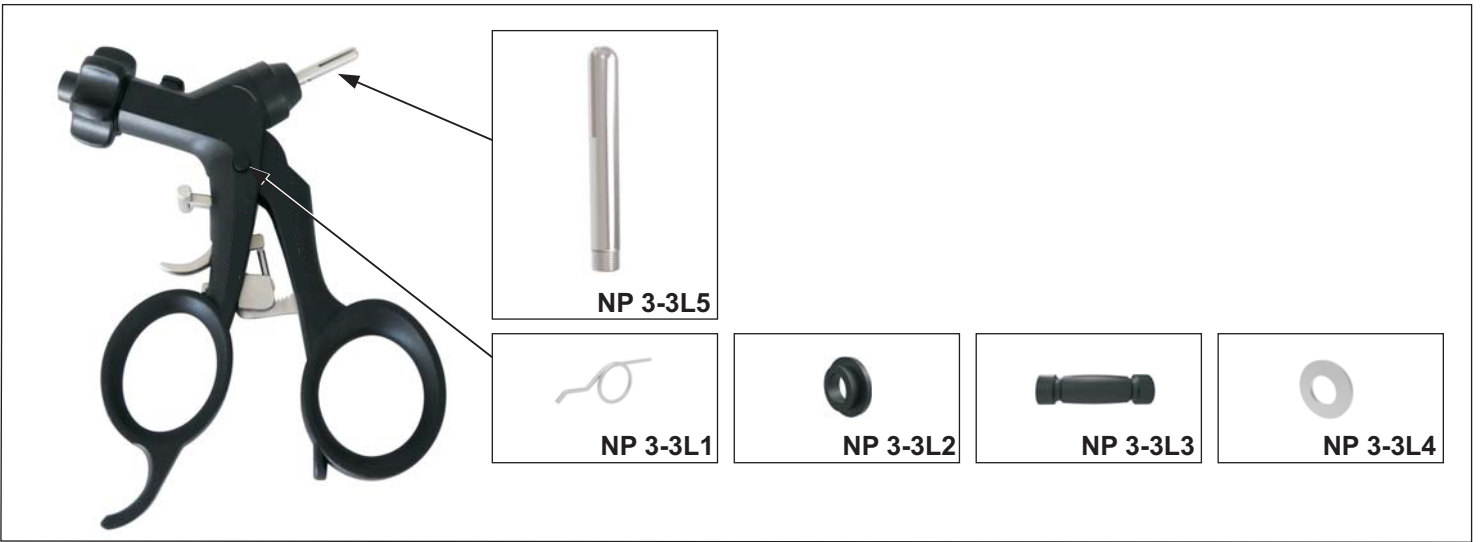

Laparoscope Spare Parts

Spare Parts usable for Multifunction-Ventil
Size 60/13 30107 M1

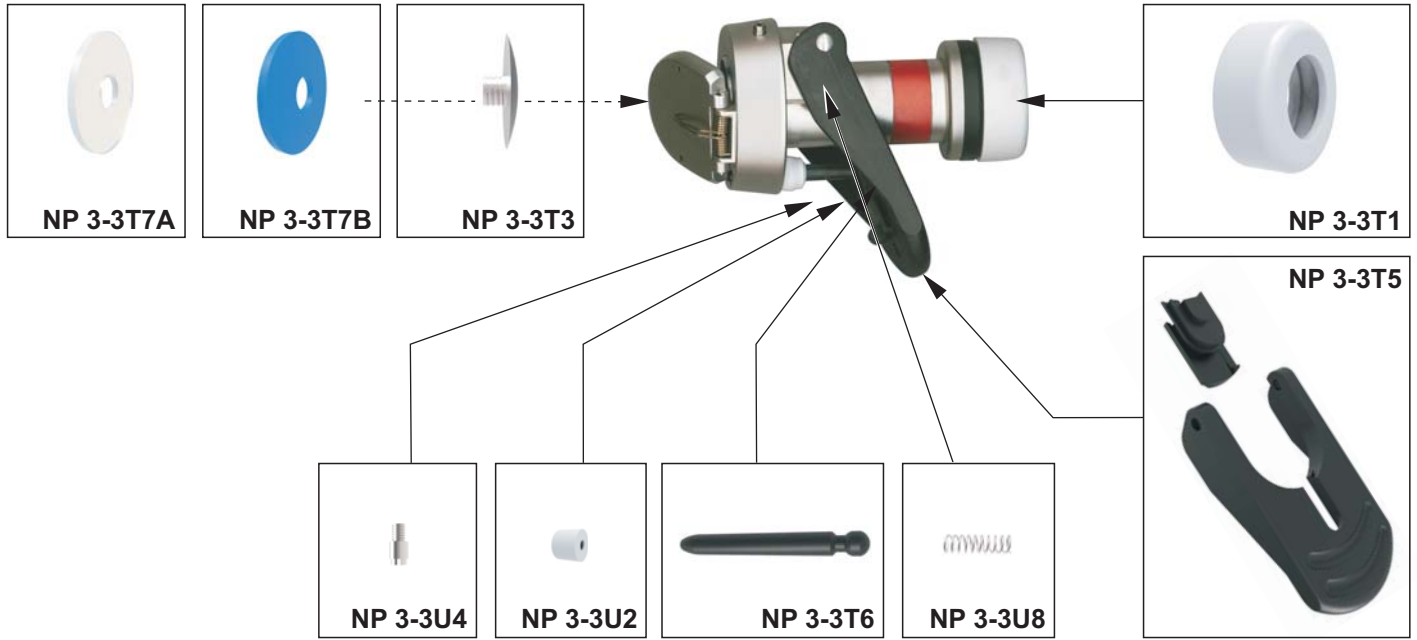

Spare Parts usable for Multifunction-Ventil
Size 60/10 30103 M1

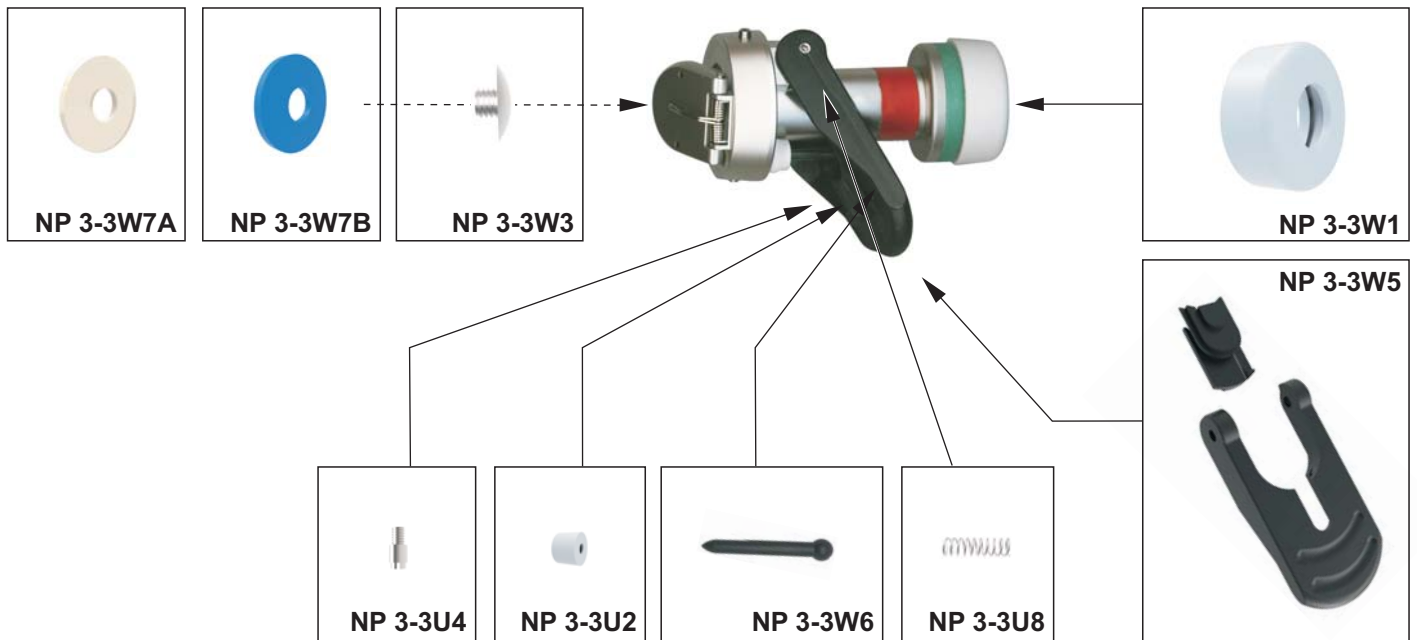

051016 NP 3-3C1

© 2016 copyright by **DANmed**

NP 3-3C1

Laparoscope Spare Parts

Spare Parts usable for Multifunction-Ventil
Size 50/4 30160 M1

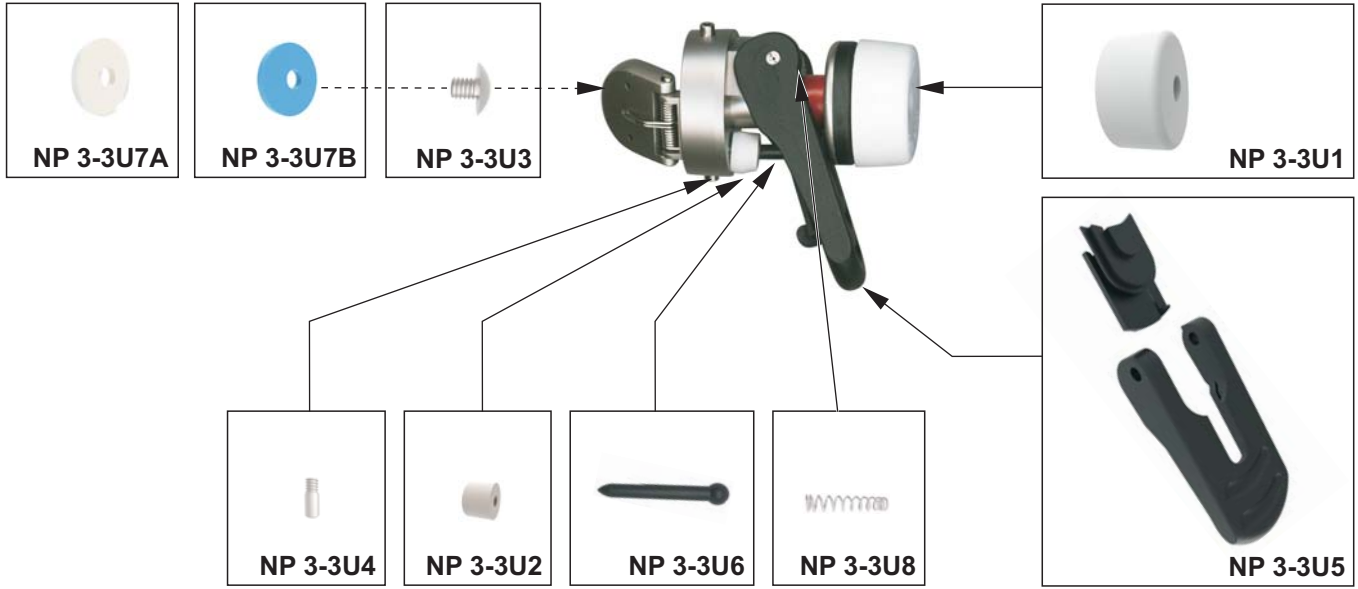

Spare Parts usable for Multifunction-Ventil
Size 50/6 30101 M1

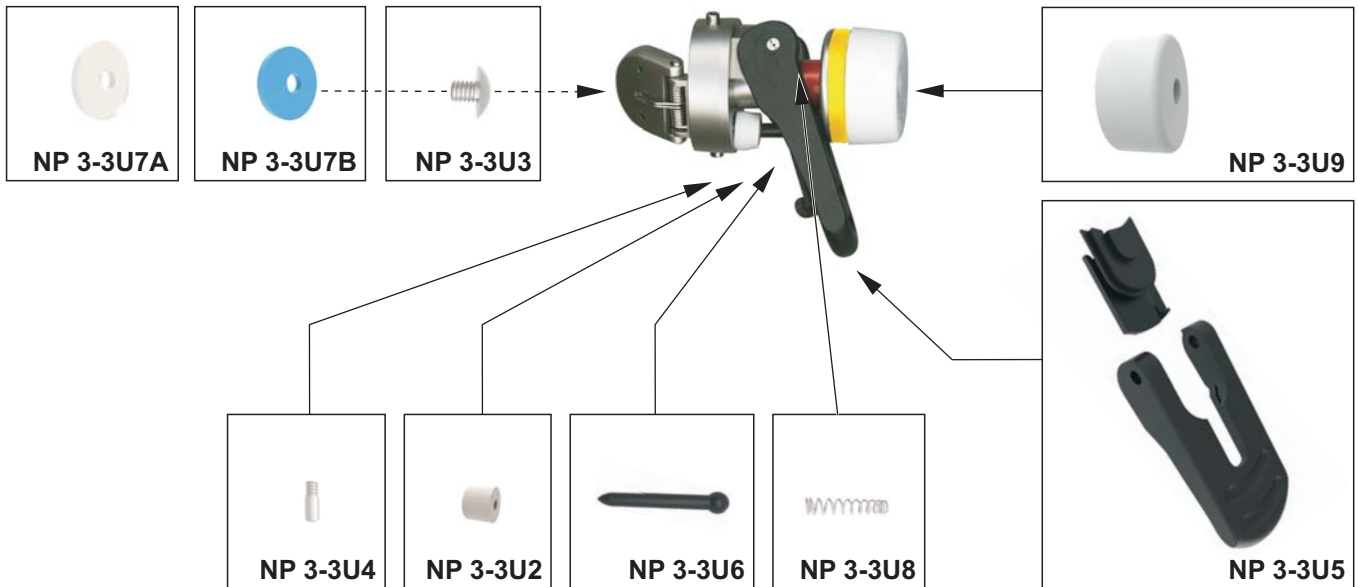

Holder for reducer 11/5mm

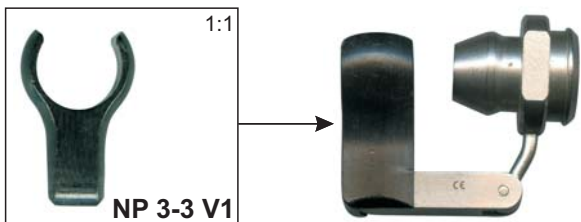

100616 NP 3-3C2

Macro Needle Holder

Complete Macro Needle Holder Insert for exchange

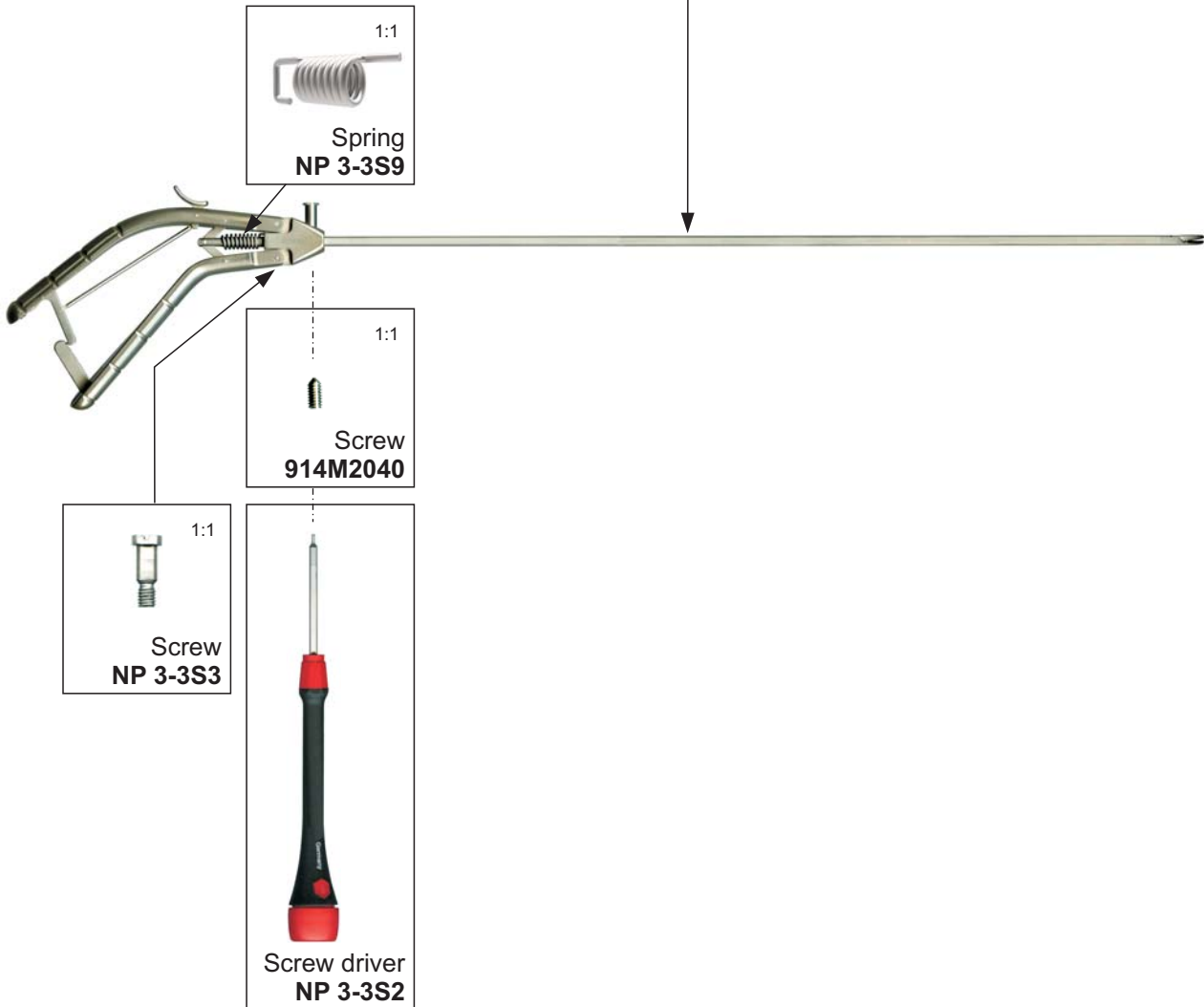
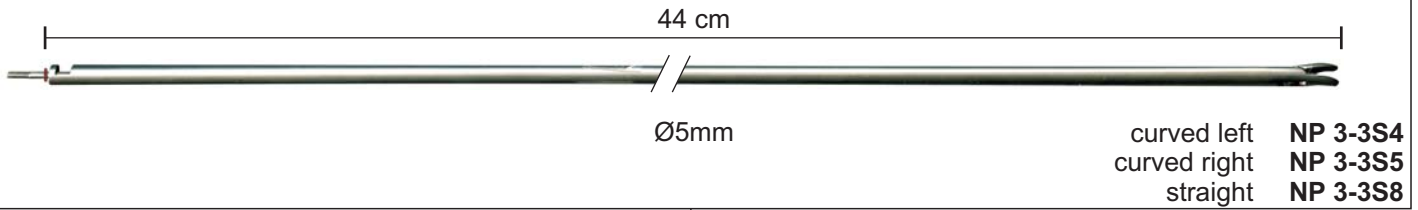
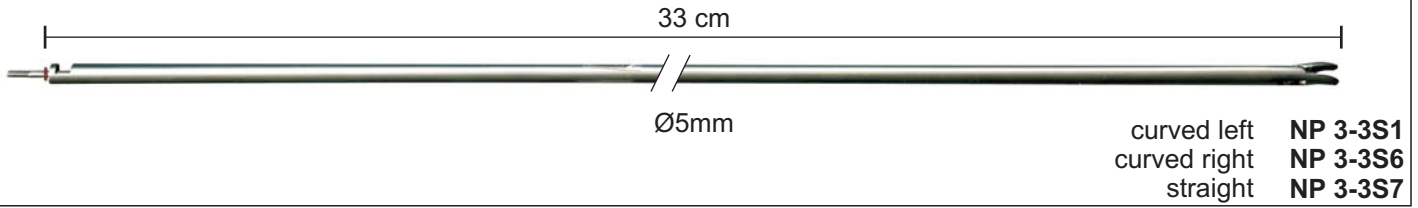

191216 NP 3-3D

© 2016 copyright by **DANmed**

NP 3-3D

Compatible parts usable for ST

Spare Parts usable for Urethrotom

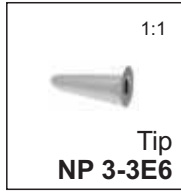

High Frequency Needle

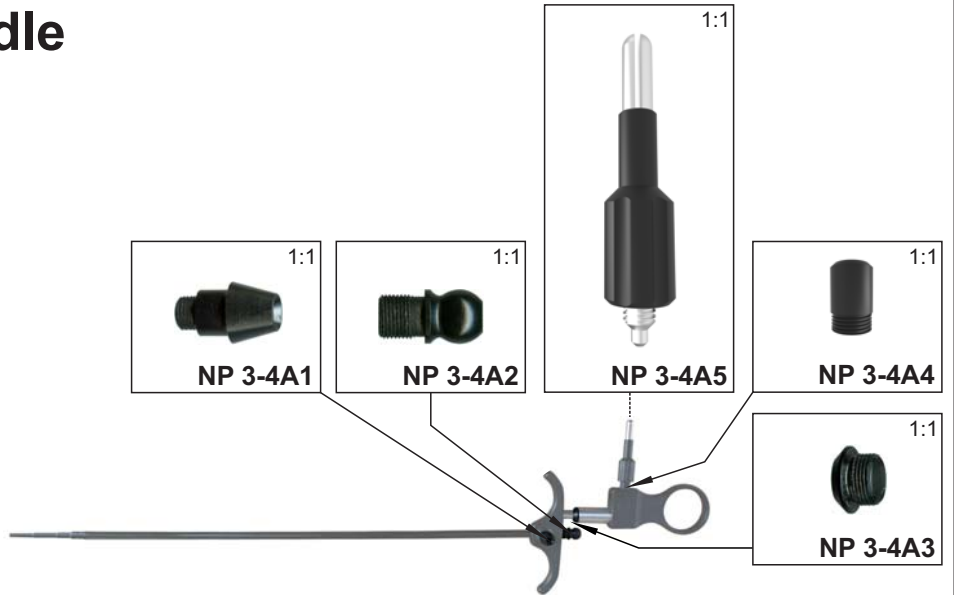

Optical Forceps usable ST

Jaw assembly

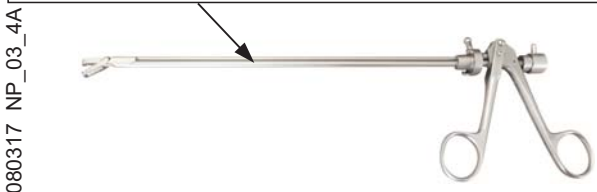
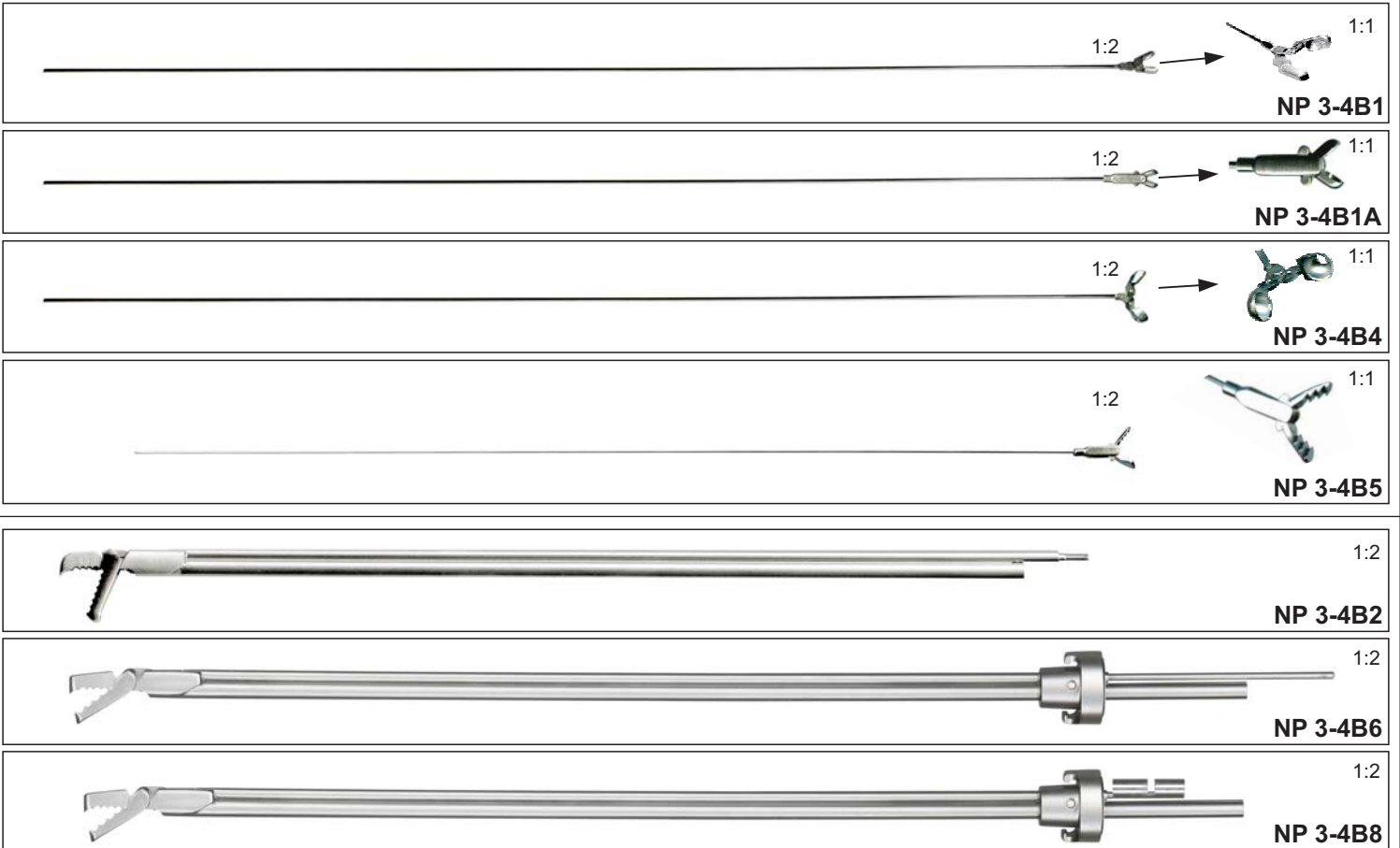

080317 NP_03_4A

Electrode Parts usable ST

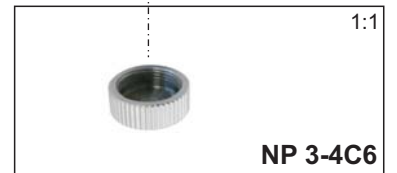
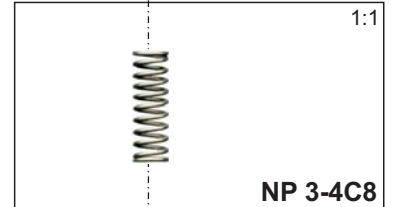
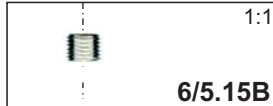
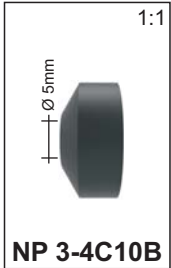
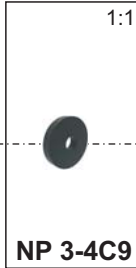
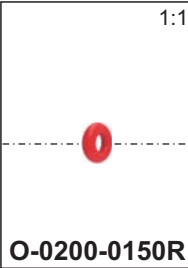
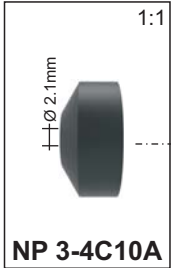
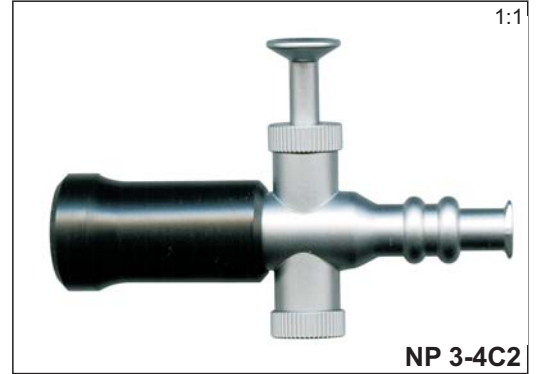
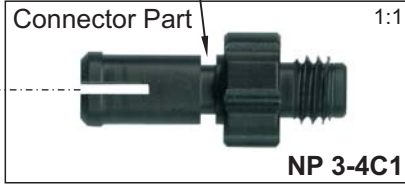
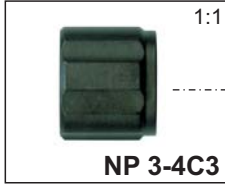

180516 NP_03_4B

Spare Parts usable Arthroscopy

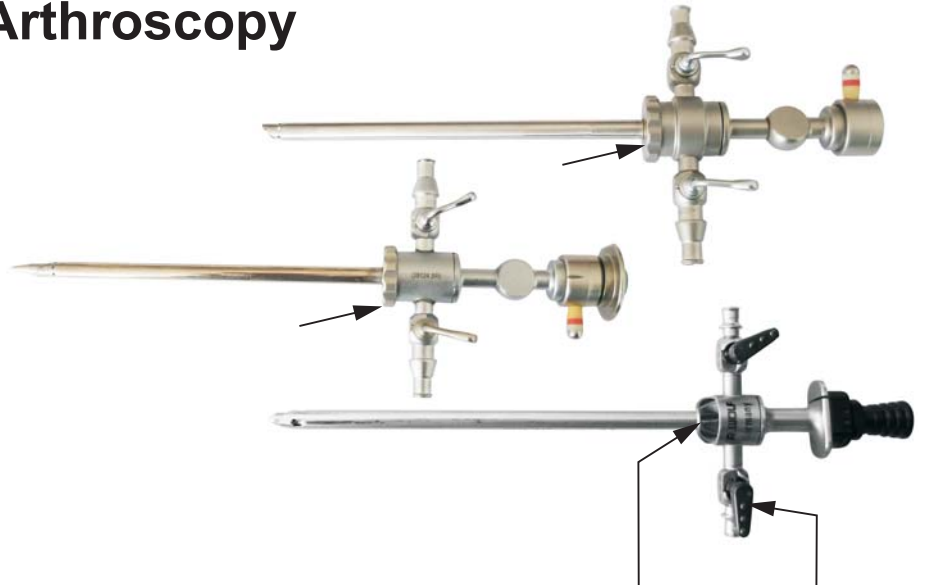

Usable for STRYKER



or



**Usable for LAP- Handle
MICROLINE**

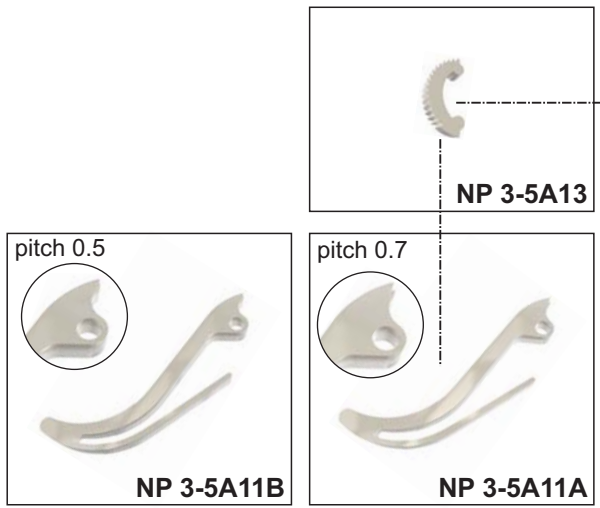
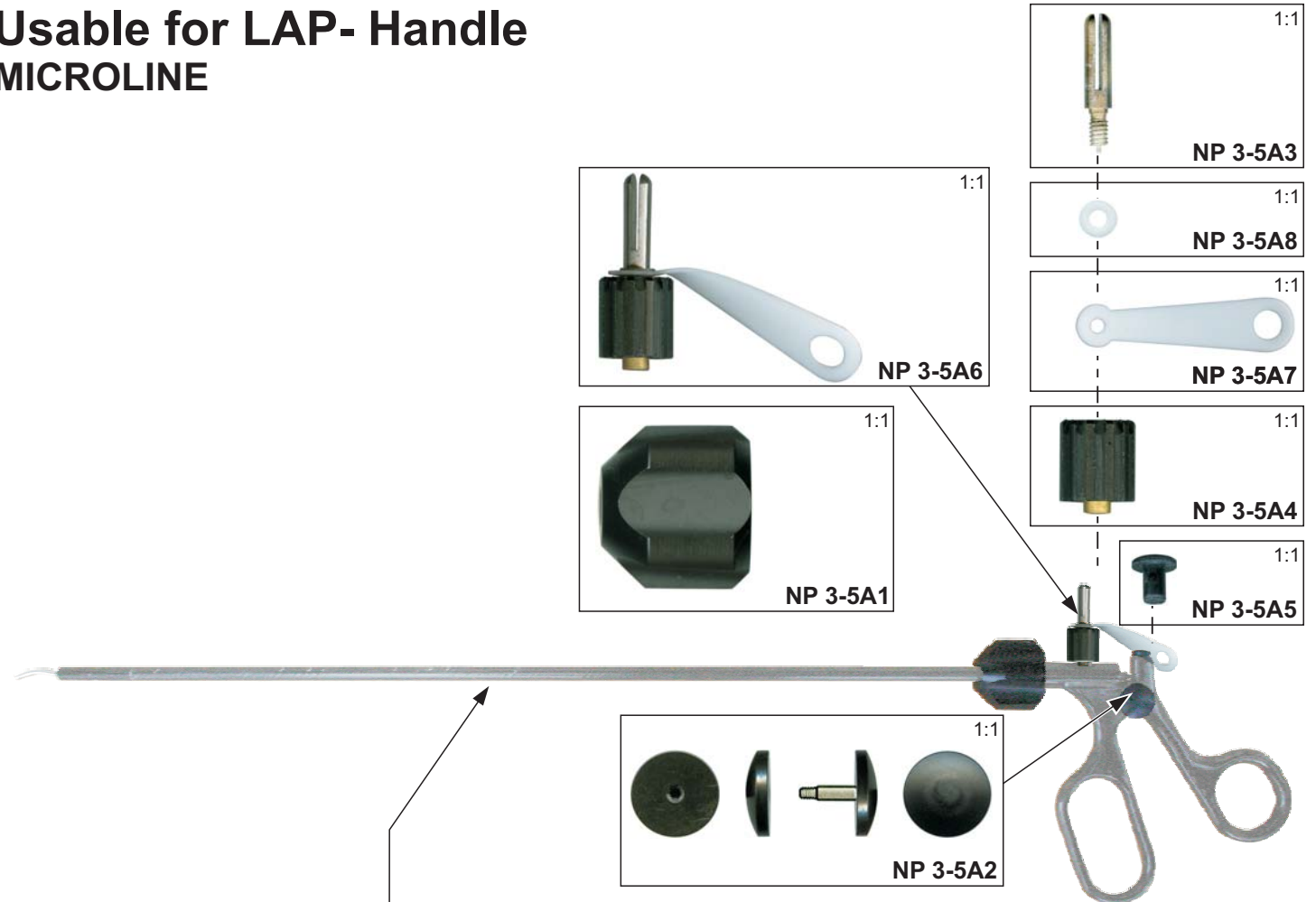

040816 NP_03_5A

© 2016 copyright by DANmed

NP 3-5A

Usable for LAP- Handle AES

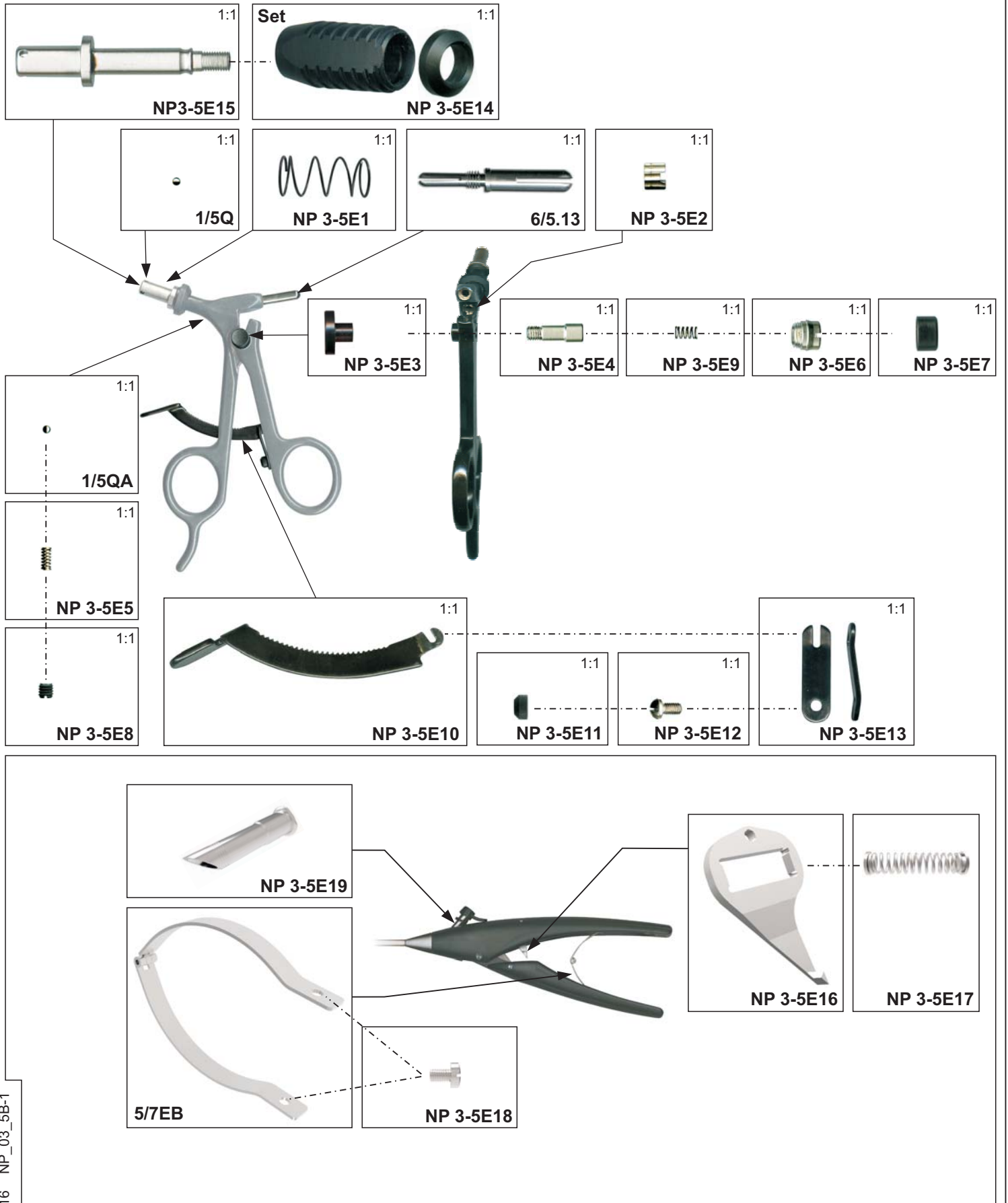

170716 NP_03_5B-1

Usable for LAP- Handle AES



080416 NP_03_5B

© 2016 copyright by **DANmed**

NP 3-5B-2

Usable for Endoplus rotating handle

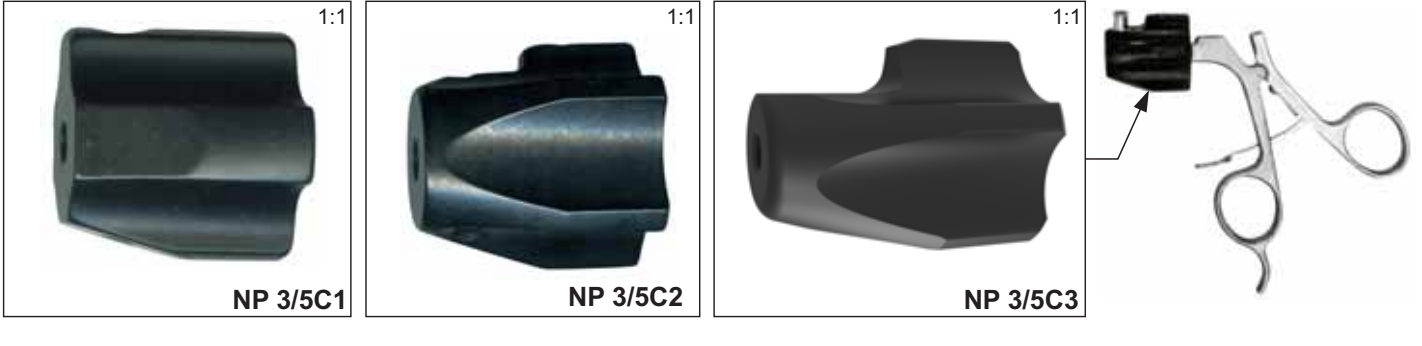

Usable for LAP- Handle AC

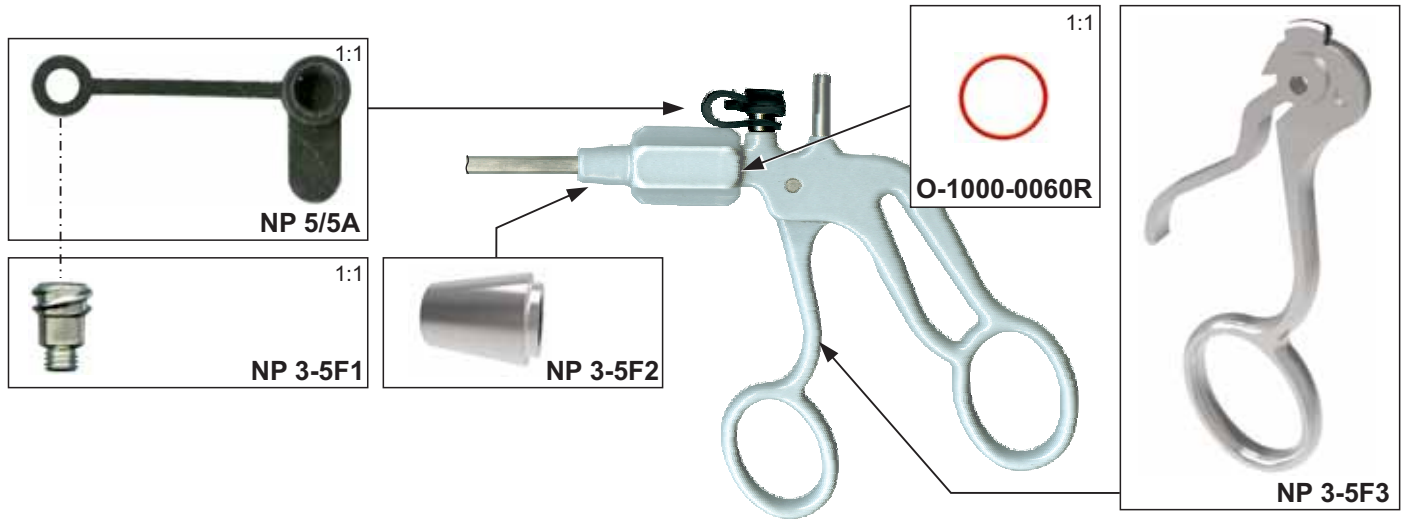

Usable for LAP- Handle DB2C

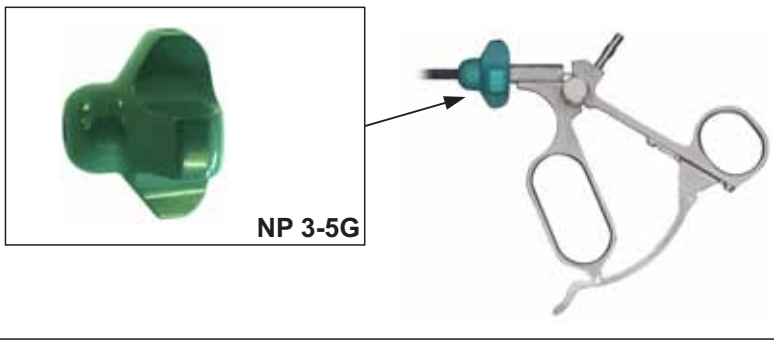

020817 NP_03_5C

Usable for ACMI LAP- Handle

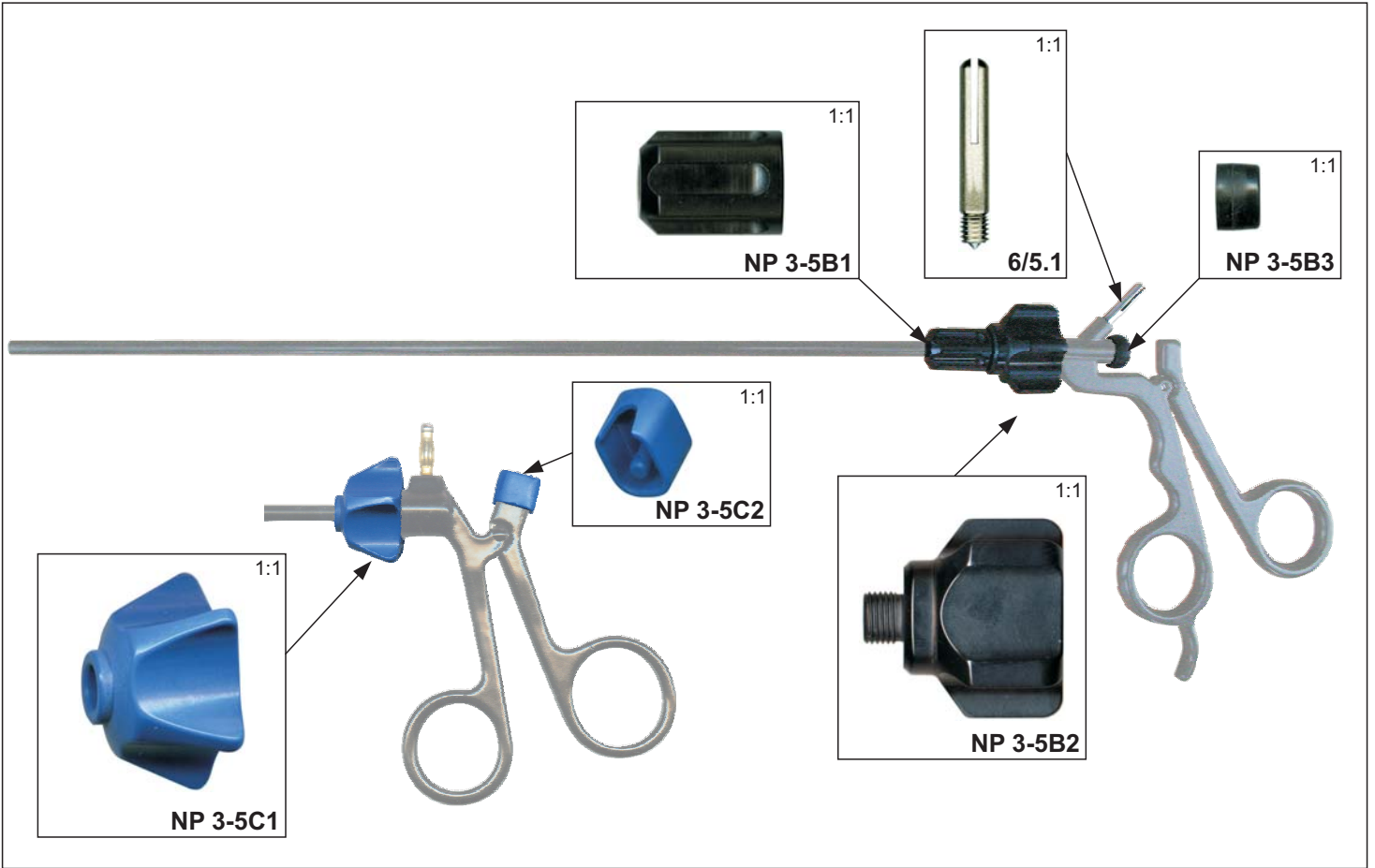

Usable for VITALITEC LAP- Handle



180216 NP_03_6

© 2016 copyright by **DANmed**

NP 3-6

Deflecting mechanism

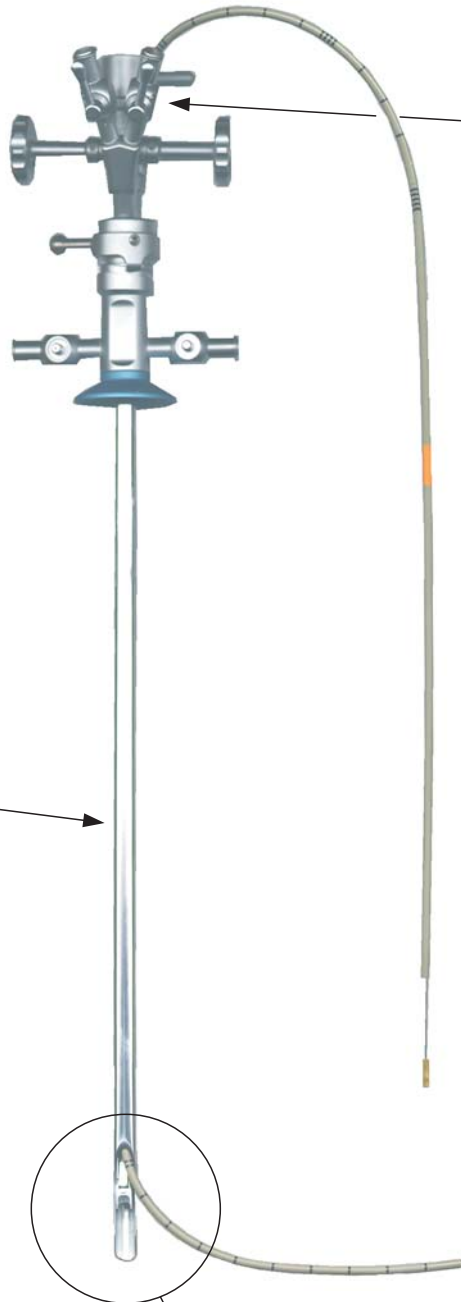
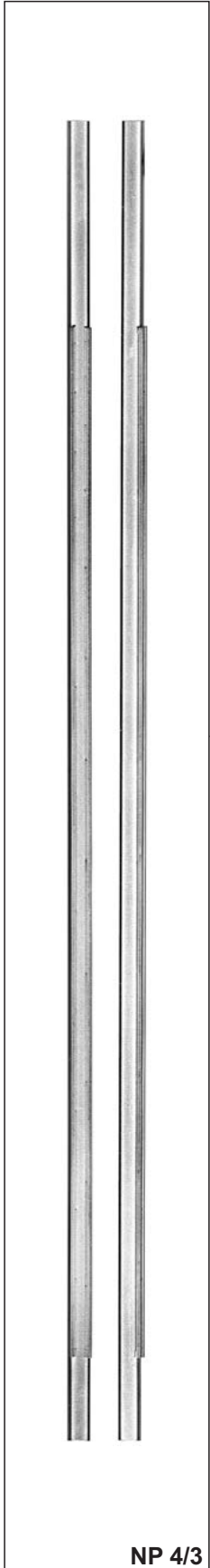

150513 NP_04

© 2016 copyright by DANmed

NP 4

Backbiting Antrum Punch

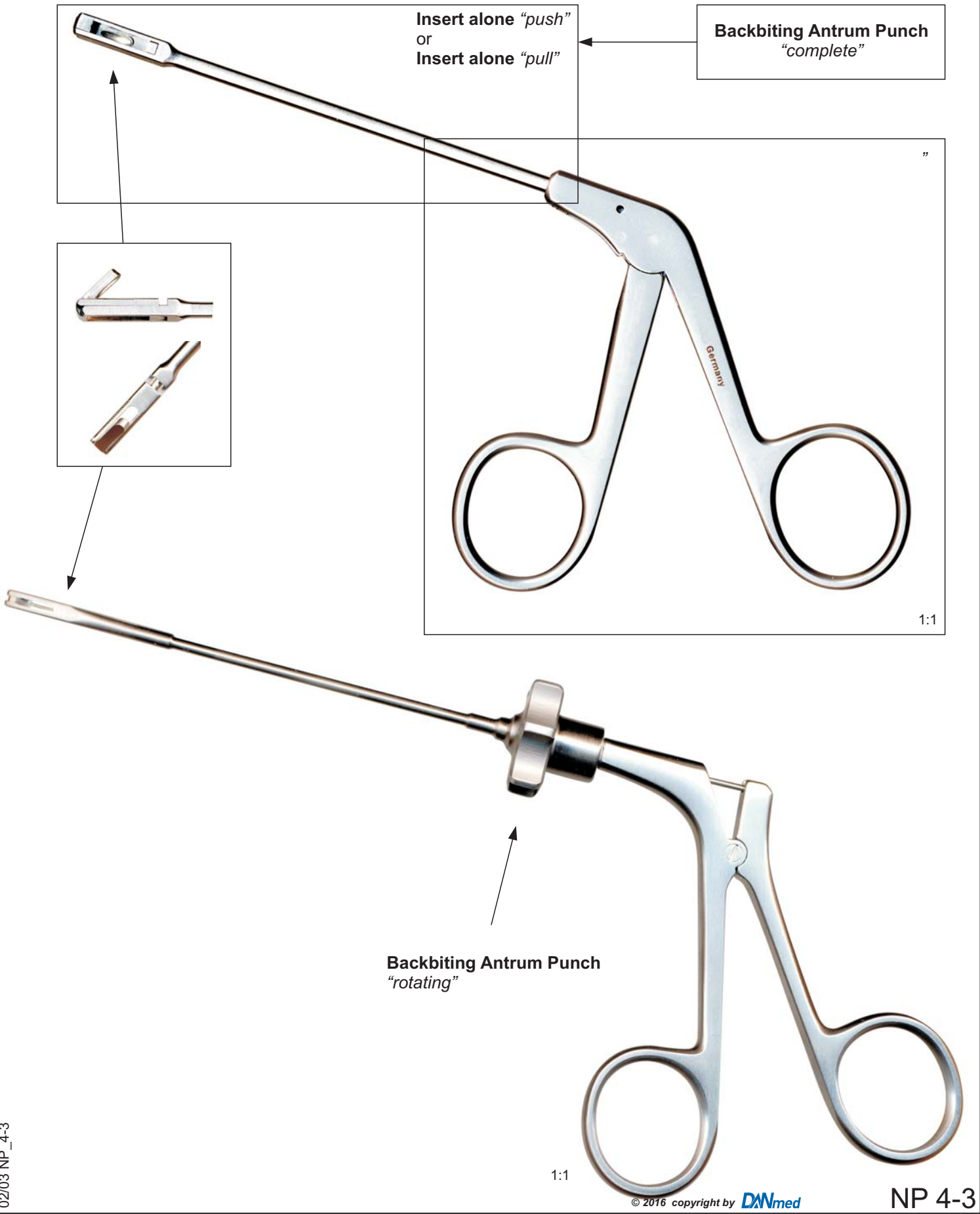

02/03 NP_4-3

1:1

© 2016 copyright by **DANmed**

NP 4-3

Parts usable for SNOWDEN & PENCER

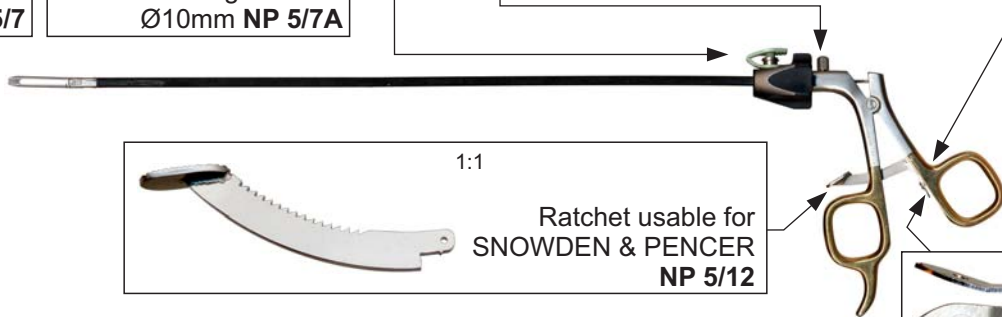
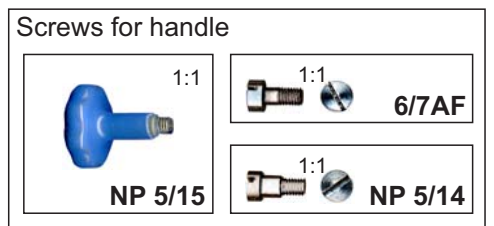
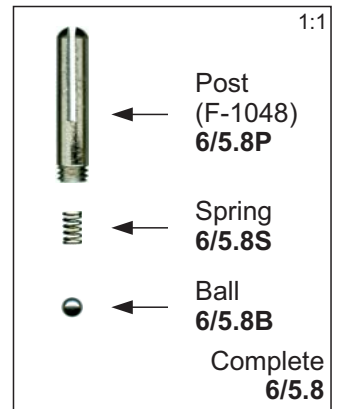
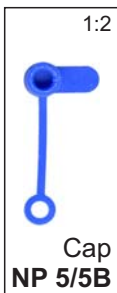
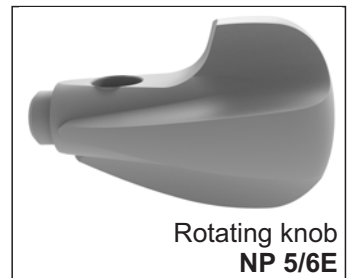
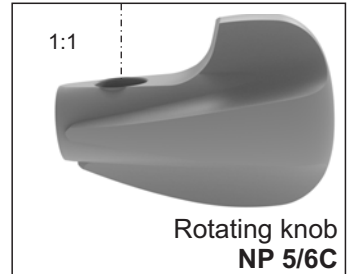
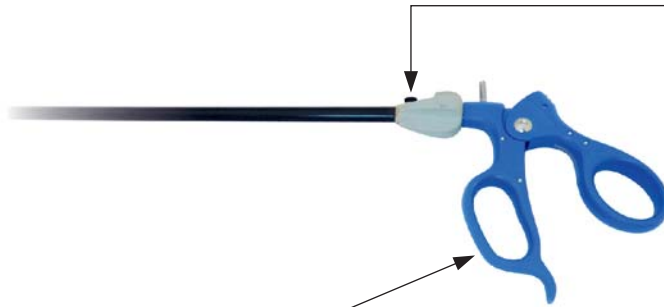

040117 NP_05-1A

Parts usable for SNOWDEN & PENCER

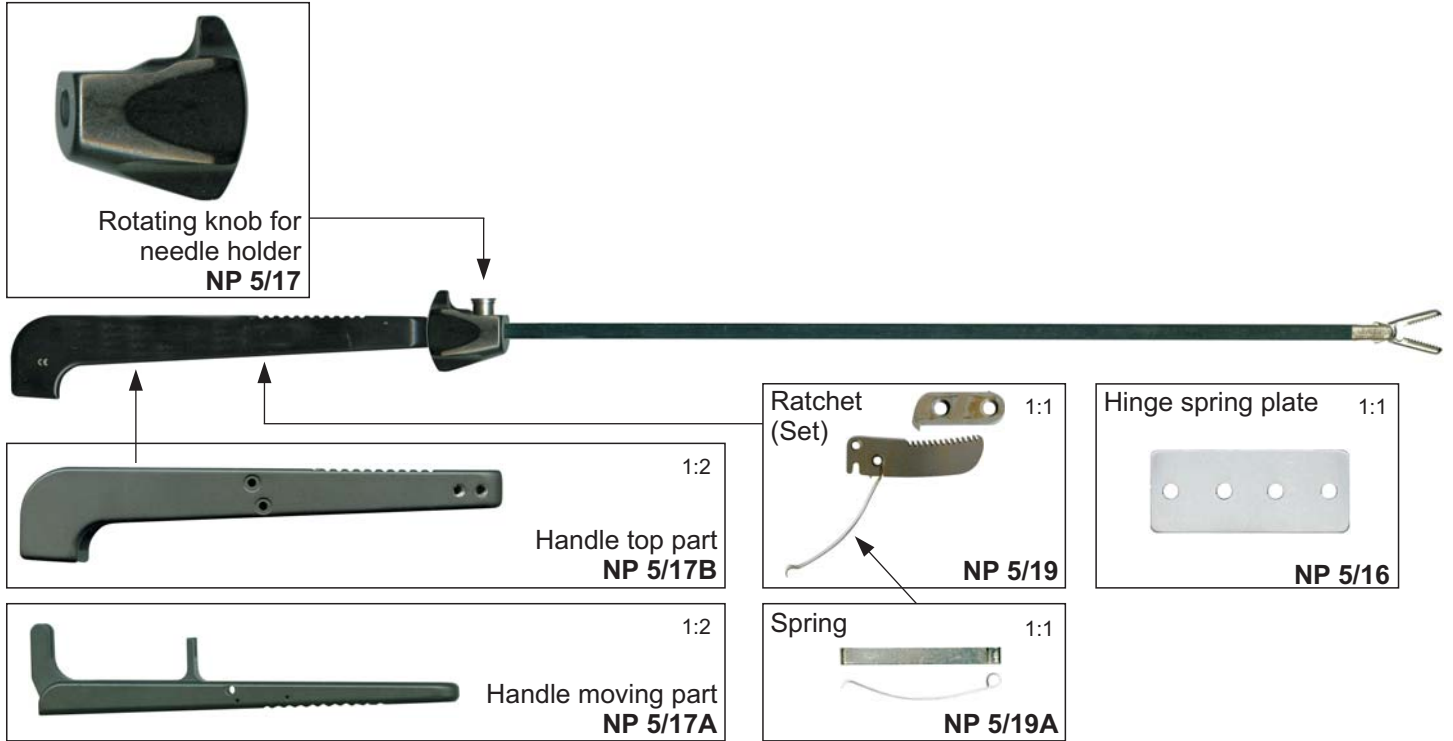

040117 NP_05-1B

© 2017 copyright by **DANmed**

NP 5-1B

Parts usable for SNOWDEN & PENCER

Memory Wire

1:2

Ø / length

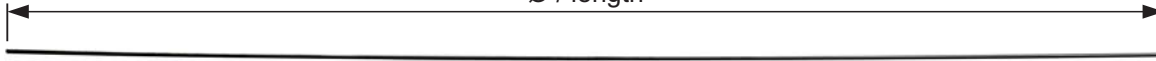

NP 5/20A	Ø0.89 / l=300mm
NP 5/20B	Ø1.20 / l=300mm
NP 5/20C	Ø1.00 / l=300mm
NP 5/20D	Ø0.60 / l=300mm
NP 5/20E	Ø0.45 / endless

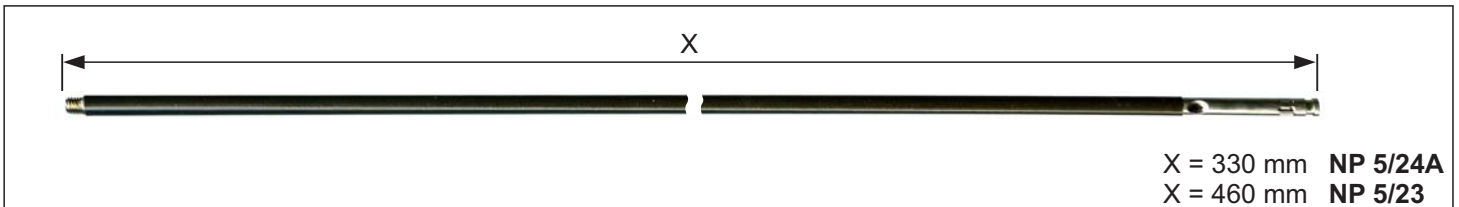
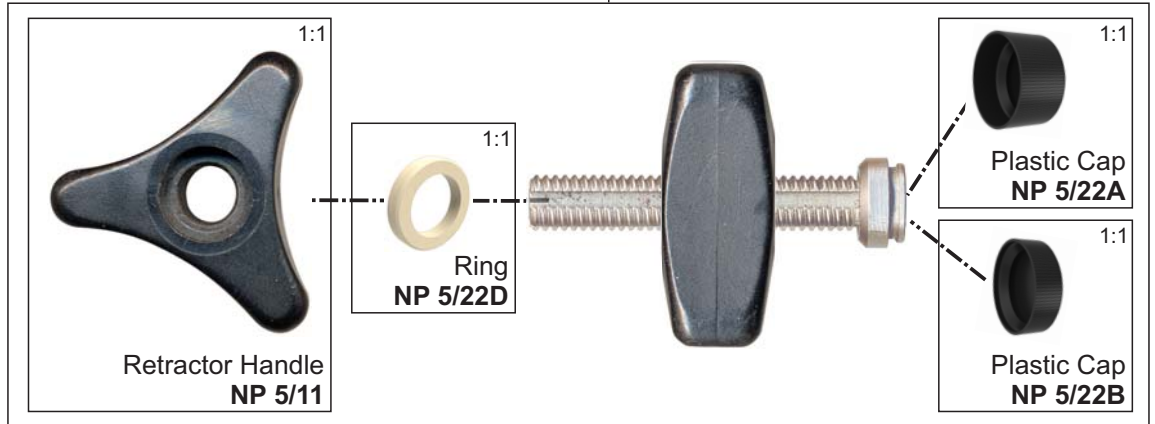
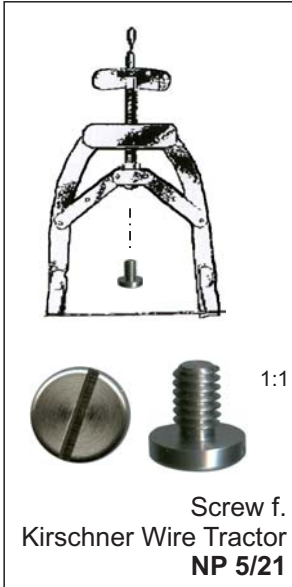
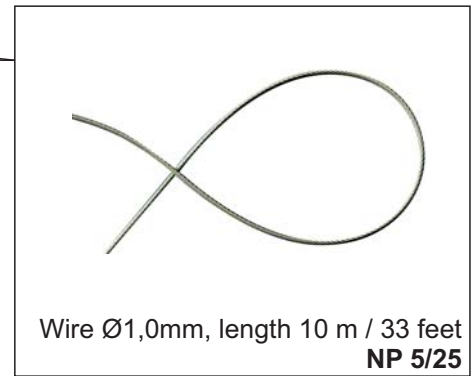

030217 NP_05-2

Parts usable for STRYKER

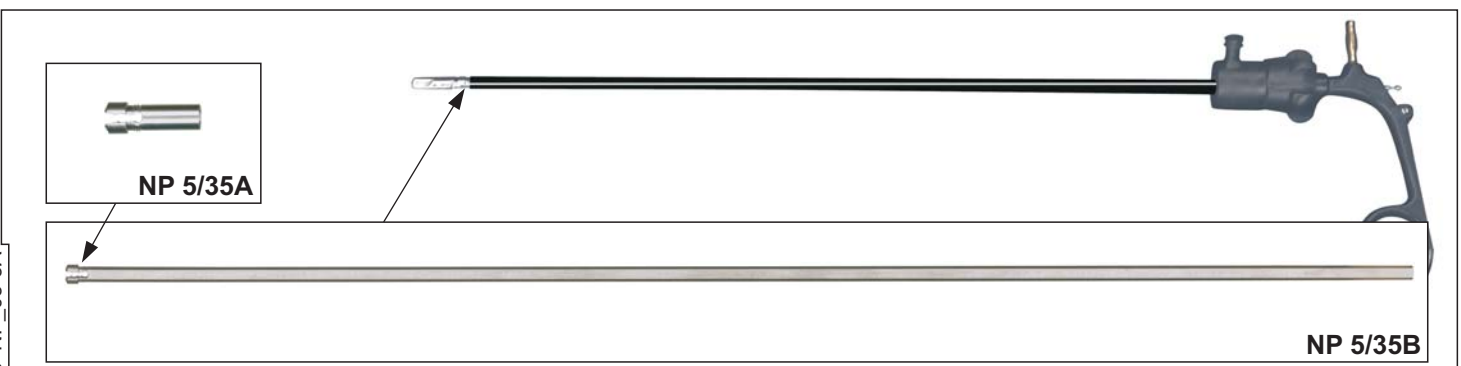
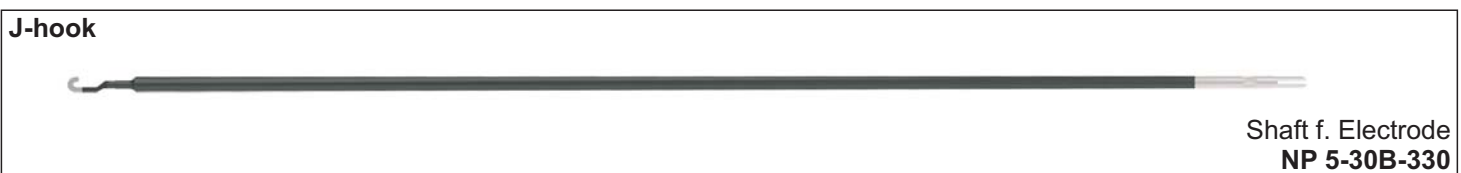
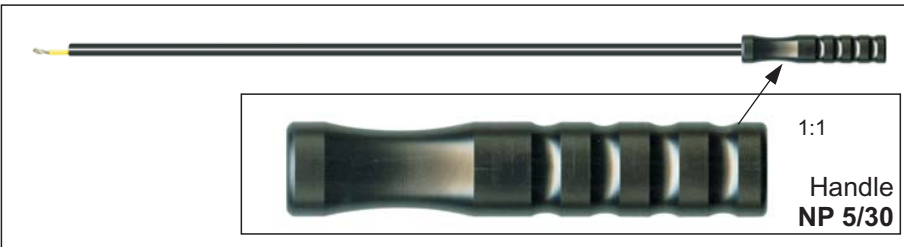
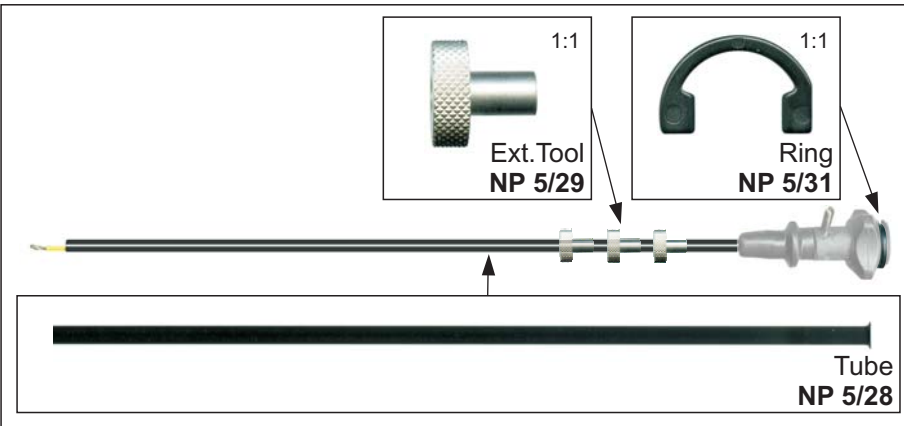
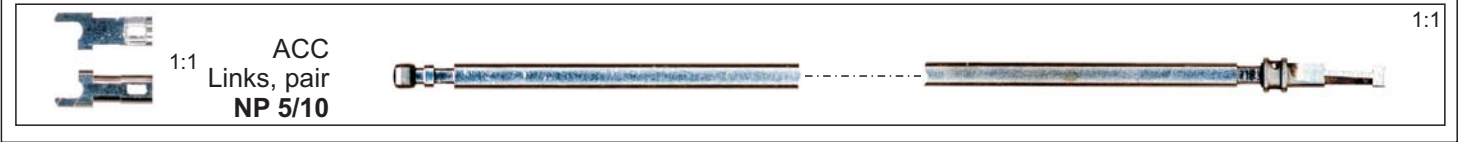

010616 NP_05-3A

Parts usable for STRYKER



1:2

NP 5/27B



1:2

NP 5/27C



NP 5/27D



NP 5/27E



Cap
NP 5/27A



NP 1/20UA



NP 5/27F

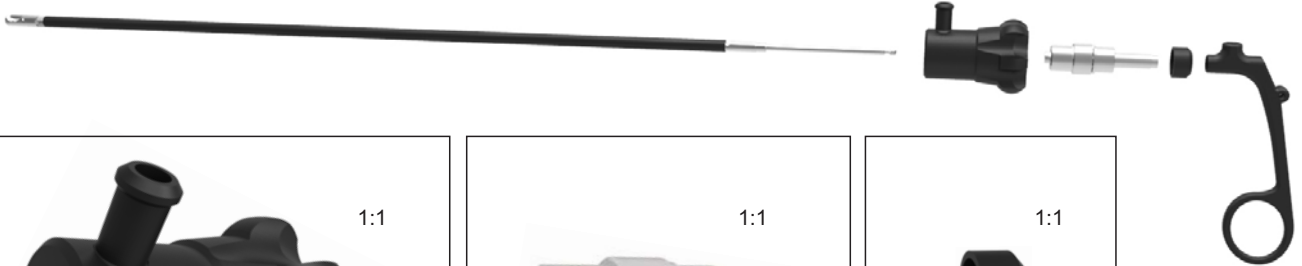

NP 5/27J

1:1



NP 5/27K

1:1



Cap
NP 1/20Q

1:1

Parts usable for STRYKER

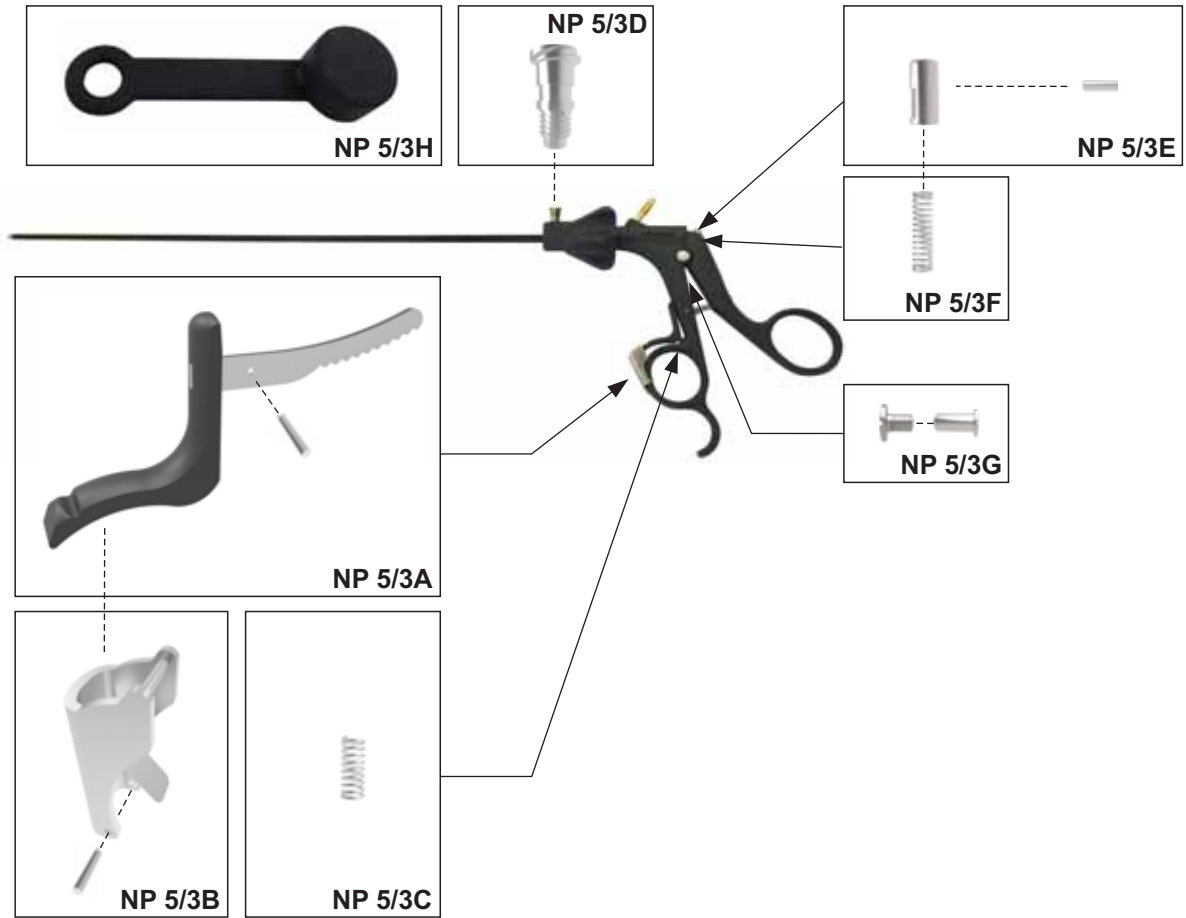

180517 NP_05-3B-2

© 2017 copyright by **DANmed**

NP 5-3B-2

Parts usable for V. Mueller

Maryland Shaft Complete, usable V. Mueller



NP 5-3A1

METZENBAUM Scissors, Shaft Complete, usable V. Mueller

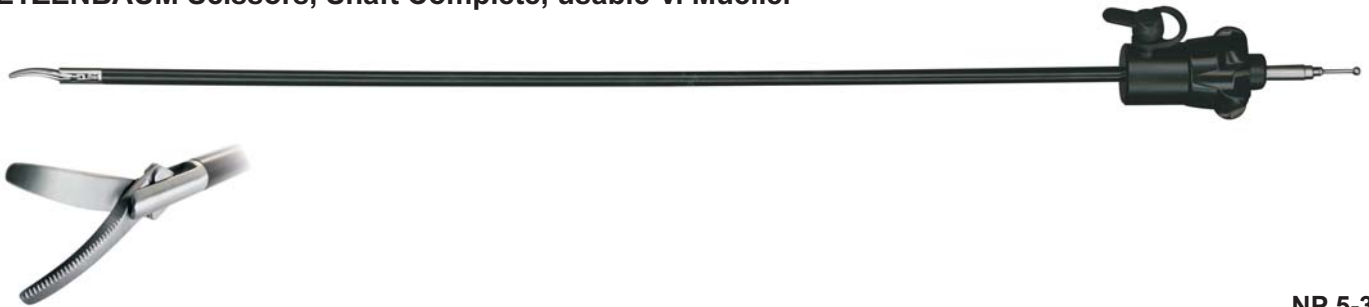

NP 5-3A2

ID 10,0 mm
OD 13,0 mm



O-1000-0150R

Rotator Ø10mm



NP 5-3B1

ID 4,4 mm
OD 8,0 mm



O-0440-0180R

Rotator Ø5mm



NP 5-3B2

Parts usable for Electrodes



Parts usable for WO

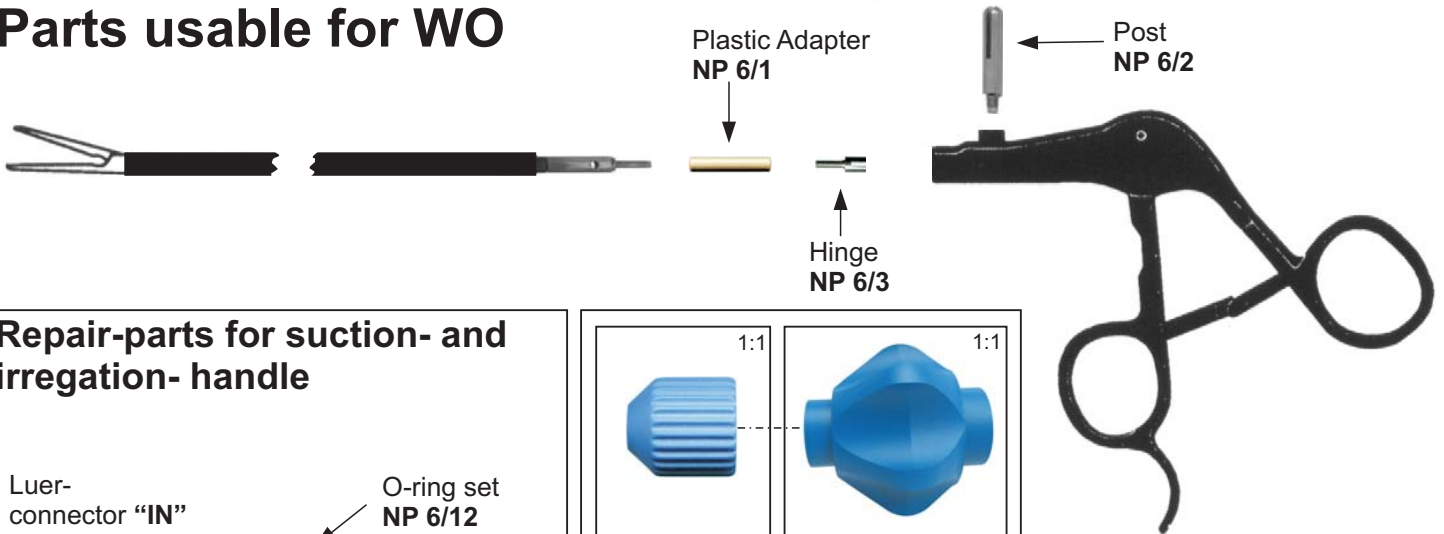

Repair-parts for suction- and irrigation- handle

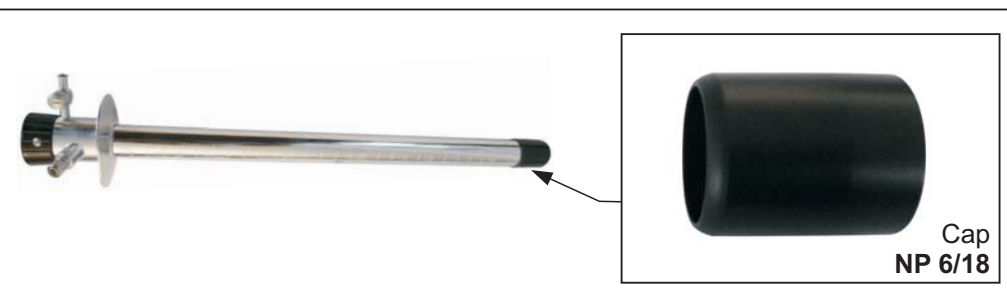
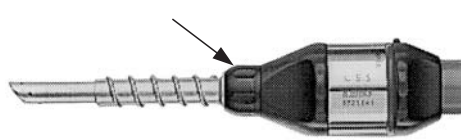
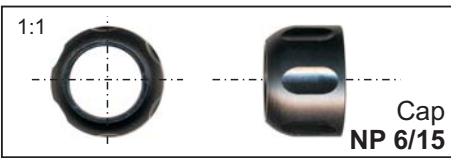
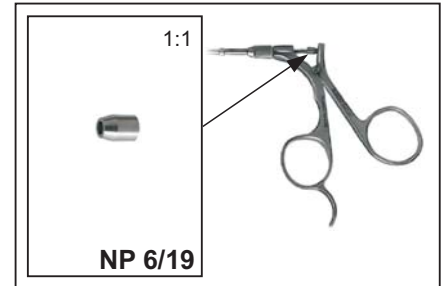
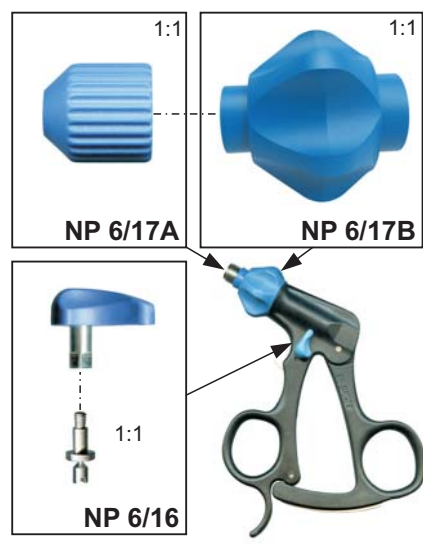
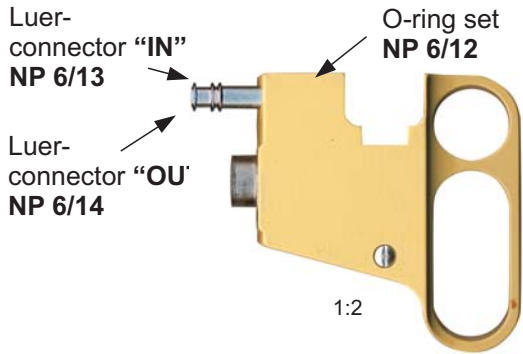

Locking device, usable for WO Arthroscopy Sheath

Locking device complete



- yellow NP 6/5A1
- green NP 6/5B1
- white NP 6/5C1

Locking device spare parts

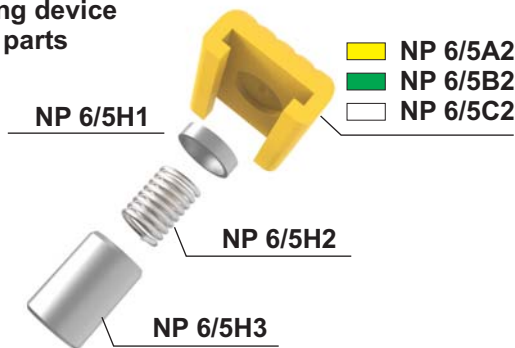

071015 NP_06-1A-1

Parts usable for WO

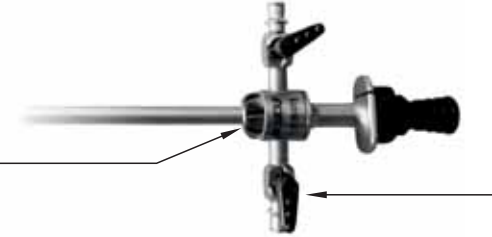
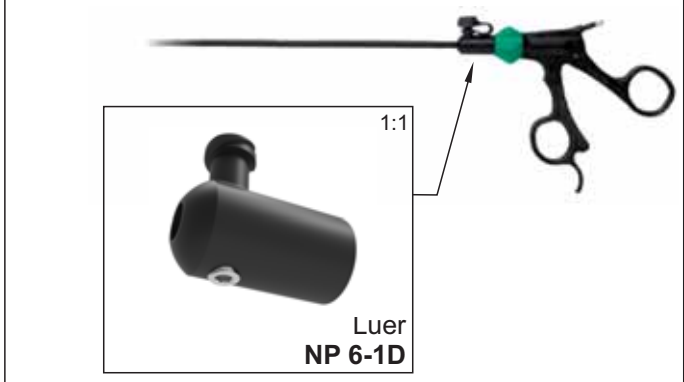
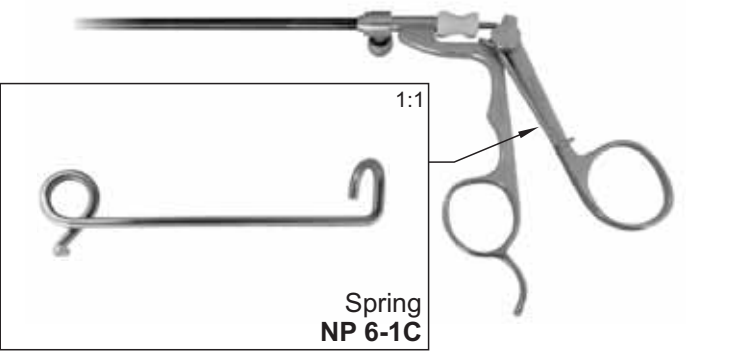
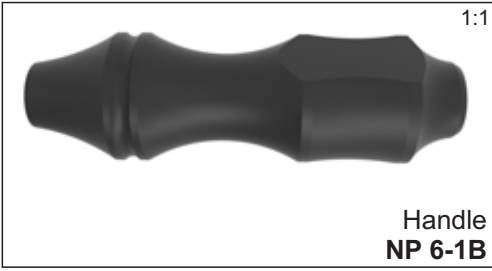

Macro- Needle Holder,
curved right



NP 6-1NR-430

NP 6-1A-2

040417 NP_06-1A-2

DAN-Electrode



Shaft for DAN-Electrode
WL = 300 mm **NP 6/10**
WL = 453 mm **NP 6/10B**



DAN-Electrode, thin hook, complete
NP 6/11



050912 NP_06-1B

Electrode parts usable for JARIT



Complete Spatula Electrode
NP 6/20-330 Length = 330 mm
NP 6/20-450 Length = 450 mm



Only Shaft for Spatula Electrode
NP 6/23-330 Length = 330 mm
NP 6/23-450 Length = 450 mm

Complete Spatula L-shaped
 Hook Electrode
NP 6/21-330 Length = 330 mm
NP 6/21-450 Length = 450 mm



Only Shaft for Spatula L-shaped
 Hook Electrode
NP 6/24-330 Length = 330 mm
NP 6/24-450 Length = 450 mm

Complete Hook Electrode
NP 6/22-330 Length = 330 mm
NP 6/22-450 Length = 450 mm



Only Shaft for Hook Electrode
NP 6/25-330 Length = 330 mm
NP 6/25-450 Length = 450 mm

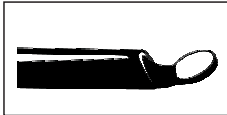
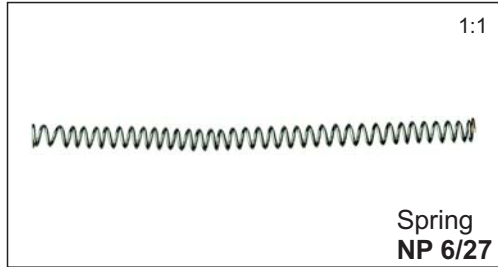

Only Shaft for Spatula Electrode
NP 6/28



Only Shaft for Spatula L-shaped
 Hook Electrode
NP 6/29



Only Shaft for Hook Electrode
NP 6/30

141015 NP_06-2

Thumb Ring & Slider



Usable for OLY



Thumb
NP 7/1

Usable for ACMI



Thumb
NP 7/2

Usable for ST



Thumb
NP 7/3

Usable for WO



Thumb
NP 7/4

Usable for WO



Thumb
NP 7/5

Usable for ST



Thumb
NP 7/6



Thumb
NP 7/14

Plastic Slide for Obturator
7,4 x 4,4 mm



1:1

NP 7/8

Plastic Slide for Obturator
7,8 x 5,0 mm



1:1

NP 7/9

Plastic Slide for Obturator
5,6 x 4,0 mm



1:1

NP 7/18



1:1

Slider
NP 7/7



1:1

Slider
NP 7/10B



1:1

Roller-
screw
NP 7/10A



1:1

Slider
NP 7/11



1:1

Slider w.
thread
NP 7/10C

310114 NP_07_01A

Lever and more

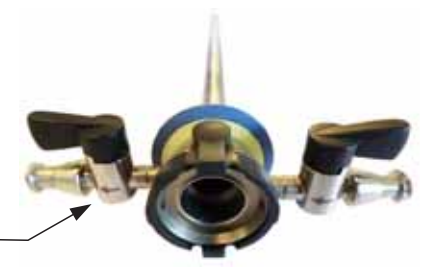
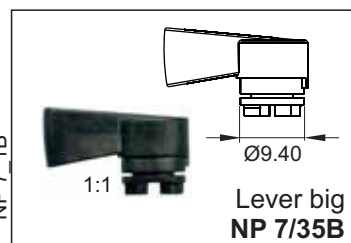
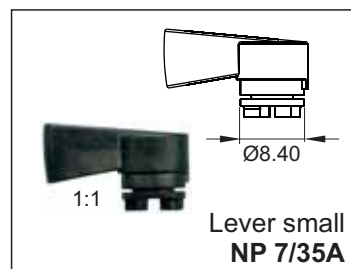
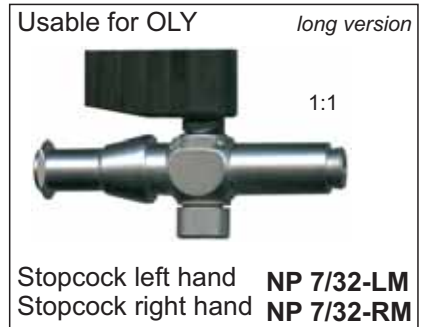
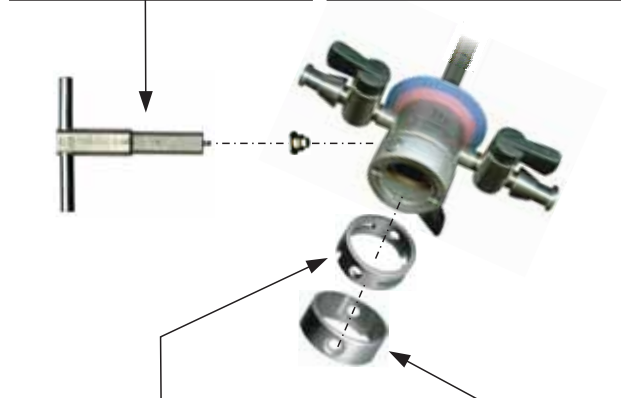
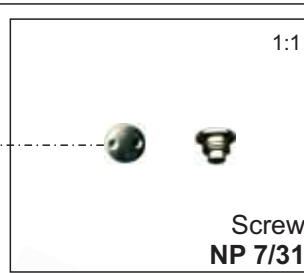
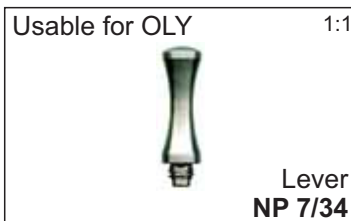
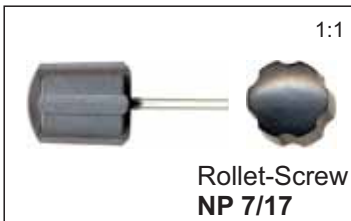
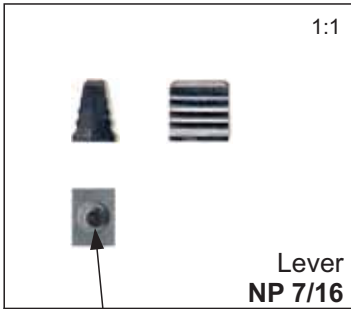
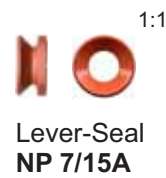
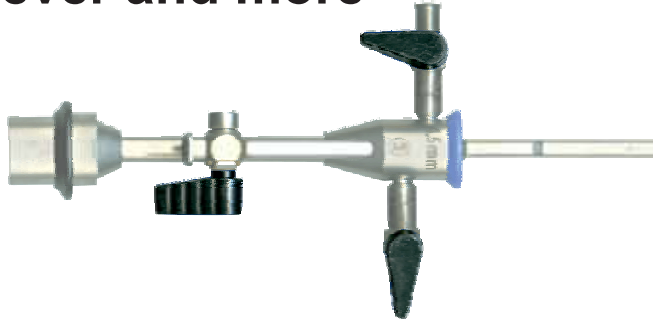

100717 NP 7_1B

Spare Parts usable vor OLY

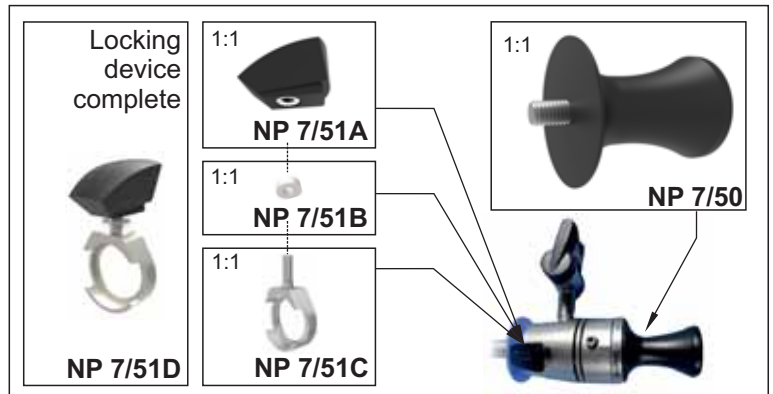
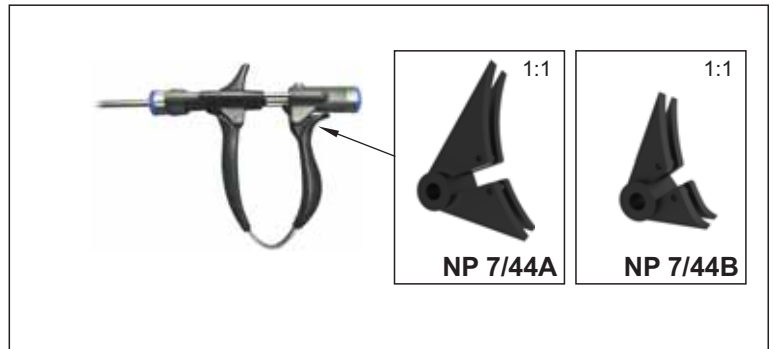
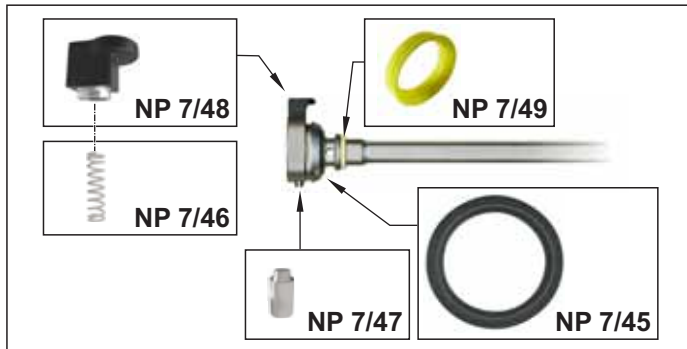
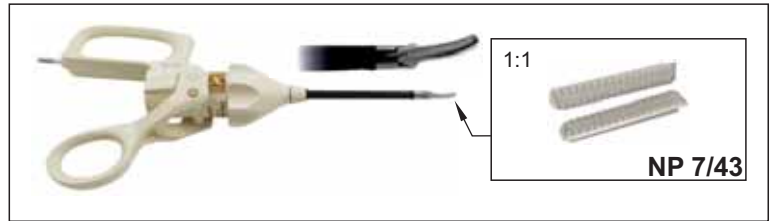
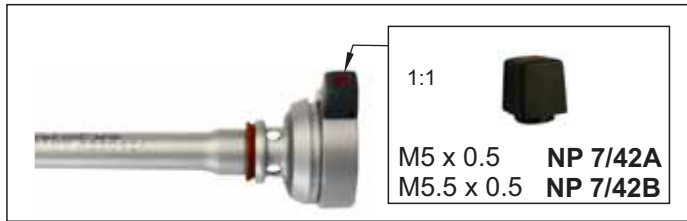
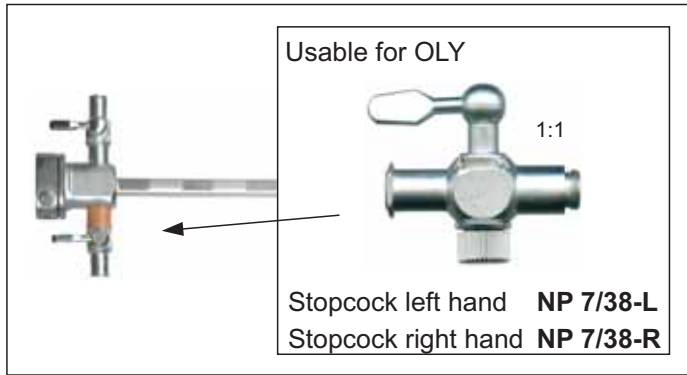

Spare Parts usable for OLY Handles and Sheats

Usable for OLY

Tube insulation



1/0P 1000mm length
1/0P-330 330mm length
1/0P-450 450mm length

Shrink Tube, double-walled



Spare release
 Button
NP 7-1C1

1:1



NP 7/41A

1:1



NP 7/40



NP 7/41B

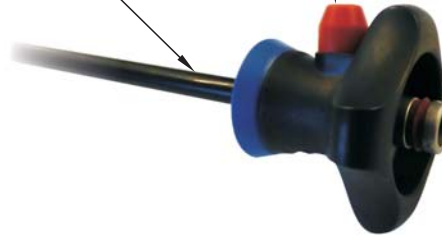

Sealing ring
NP 7-1C2

Shaft insulated.
 refurbished



Monopolar 330mm **A60800A-REF**
 Monopolar 430mm **A60800L-REF**

Lever and more

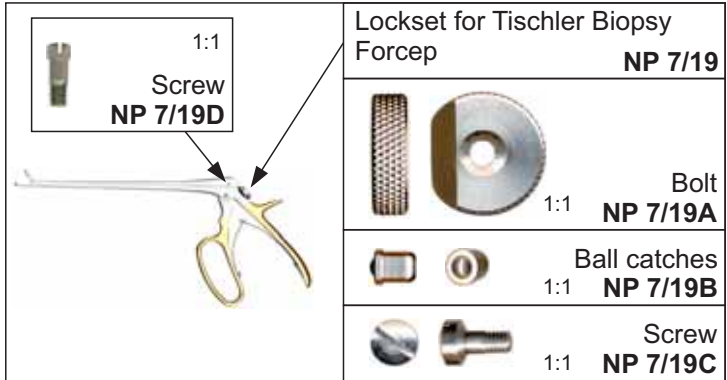

Handle and more

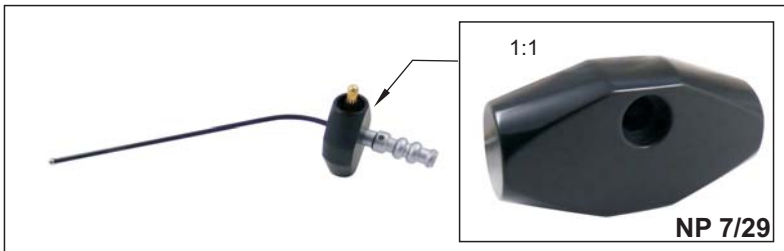
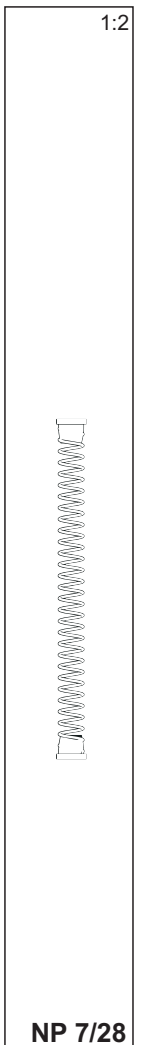
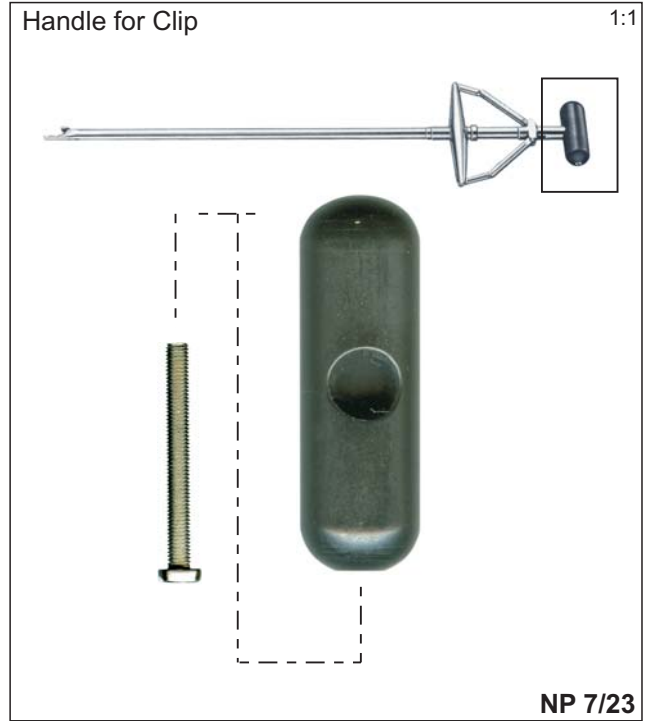

300914 NP_07_02

Handles



1:2
Ø 32 mm
l = 136 mm
NP 8/1

1:2
Ø 22 mm
l = 116 mm
NP 8/2



1:2
Ø 30 mm
l = 141 mm
NP 8/5



1:2
Ø 22 mm
l = 117 mm
NP 8/2-B



1:2
Ø 30 mm
l = 141 mm
NP 8/5-B



1:2
Ø 16 mm
l = 102 mm
NP 8/3



1:2
Ø 36 mm
l = 111 mm
NP 8/6



1:2
Ø 16 mm
l = 102 mm
NP 8/3-B



1:2
Ø 30 mm
l = 121 mm
NP 8/7



1:2
Ø 30 mm
l = 110 mm
NP 8/4



1:2
Ø 30 mm
l = 121 mm
NP 8/7-B



1:2
Ø 30 mm
l = 110 mm
NP 8/4-B



1:1
Ø 1.9 → Ø 2.13
l = 11 mm
NP 8-1A



1:1
Ø 1.9 → Ø 2.13
l = 16 mm
NP 8-1B



1:1
Ø 2.4 → Ø 2.6
l = 20 mm
NP 8-1C

230915 NP_08_1A1

Handles



1:2
Ø 39 mm
l = 110 mm
NP 8/8



1:2
Ø 40 mm
l = 110 mm
NP 8/8-B



1:2
Ø 31 mm
l = 115 mm
NP 8/10



1:2
Ø 27 mm
l = 122 mm
NP 8/11



1:2
Ø 28 mm
l = 136 mm
NP 8/12



1:2
Ø 29 mm
l = 122 mm
NP 8/13-B



1:2
Ø 20 mm
l = 100 mm
NP 8/14-B

Ø 7,2
Ø 2,4

1:2
Ø 30 mm l = 170 mm
NP 8/15-B



1:2
Ø 30 mm
l = 115 mm
NP 8/30-B



1:2
Ø 30 mm l = 170 mm
NP 8/31-B



1:2
Ø 30 mm l = 180 mm
NP 8/32-B



1:2
Ø 31.5 mm
l = 124.5 mm
NP 8/33-B



1:2
Ø 30 mm
l = 146 mm
NP 8/34-B

230517 NP_08_1A2

Handles



1:2

M16x1.5 mm
l = 235 mm

NP 8/23-B

170616 NP_08_1A3

© 2016 copyright by **DANmed**

NP 8-1A3

Mallet Head

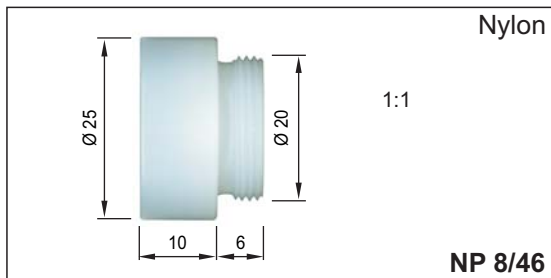
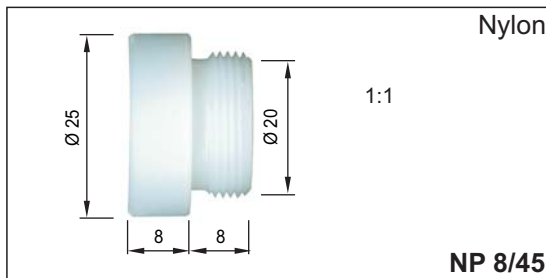
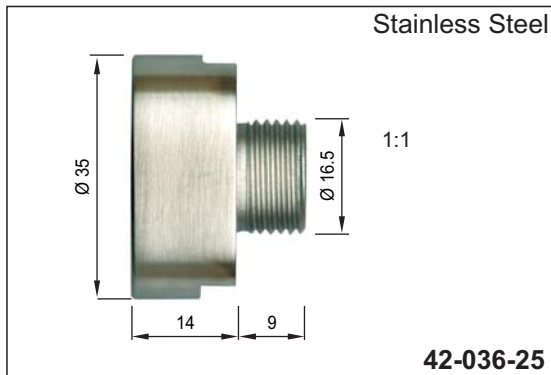
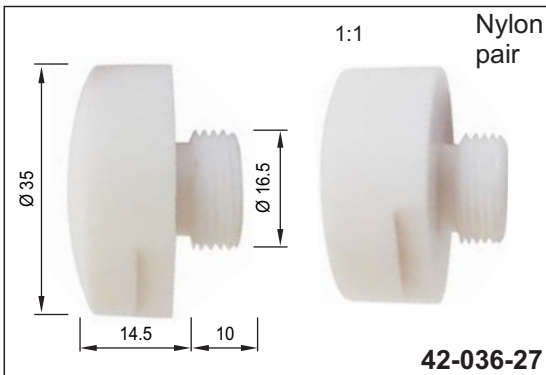
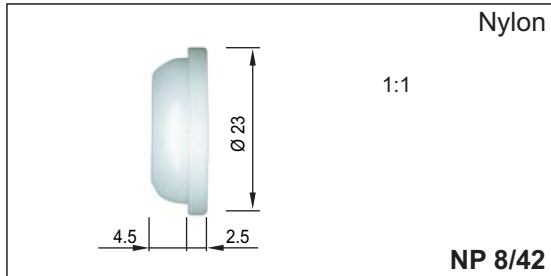
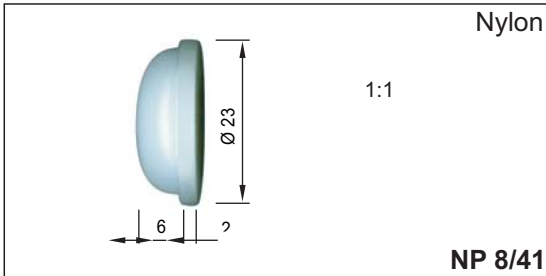
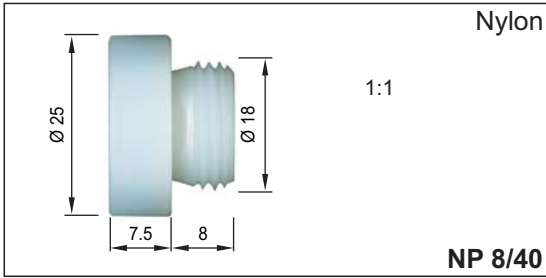
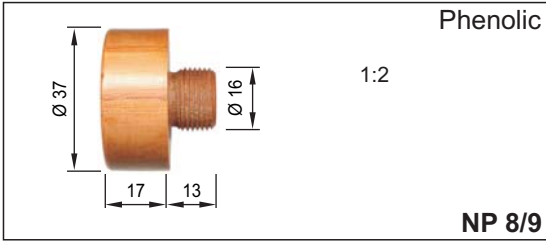

120416 NP_08_1B

Mallet Head

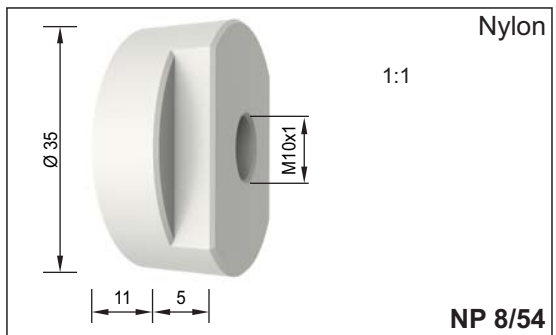
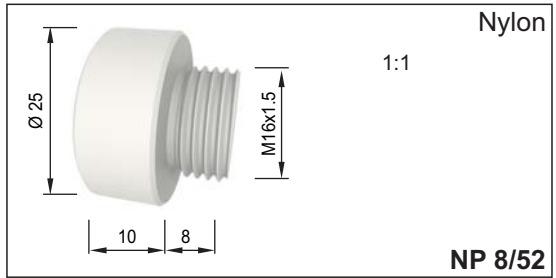
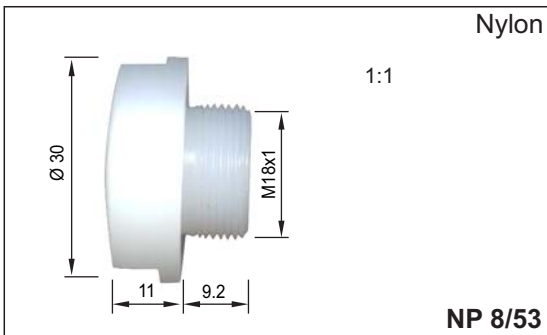
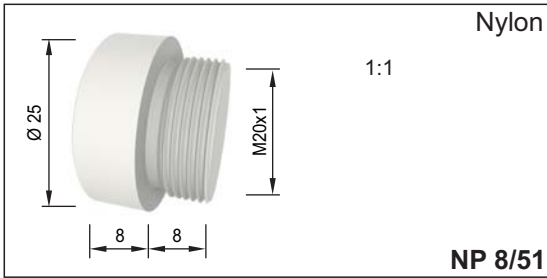
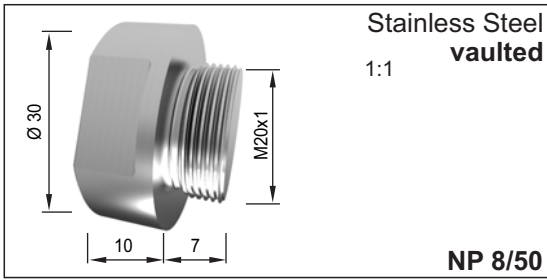
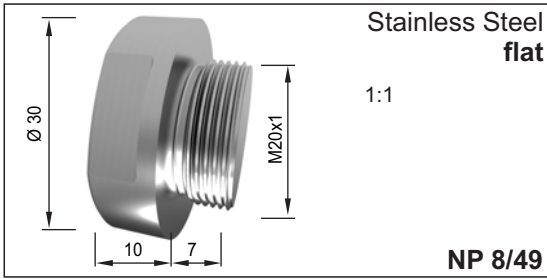

Eyepiece, PPSU Poly (phenylsulfon) Radel

<p>usable for ACMI 1:1</p>  <p>Window screw NP 9/3</p>	<p>usable for ACMI 1:1</p>  <p>NP 9/1</p>	<p>usable for WO 1:1</p>  <p>NP 9/4</p>
<p>usable for ACMI 1:1</p>  <p>NP 9/2</p>	<p>usable for ACMI 1:1</p>  <p>NP 9/2</p>	<p>usable for WO 1:1</p>  <p>NP 9/5</p>
<p>usable for ST 1:1</p> <p>not available</p>  <p>NP 9/6</p>	<p>usable for ST 1:1</p>  <p>NP 9/8A</p>	<p>usable for OLY 1:1</p>  <p>NP 9/9</p>
<p>usable for OLY 1:1</p>  <p>NP 9/10</p>	<p>usable for ST 1:1</p> <p>not available</p>  <p>NP 9/7</p>	<p>usable for ST 1:1</p>  <p>NP 9/8B</p>
<p>usable for Linvatec 1:1</p>  <p>NP 9/11</p>	<p>usable for Linvatec 1:1</p>  <p>NP 9/12</p>	
<p>usable for Stryker 1:1</p>  <p>NP 9/13</p>	<p>usable for Stryker 1:1</p>  <p>NP 9/14</p>	<p>usable for DYONICS 1:1</p>  <p>NP 9/15</p>
<p>usable for OLY 1:1</p>  <p>NP 9/17</p>		

030817 NP_09-1

Protector tube

usable for Endoscope or Cystoscope

or extension for Cystoscopy

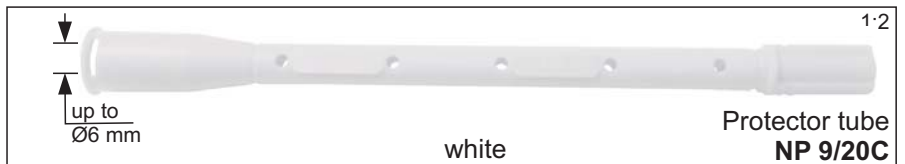
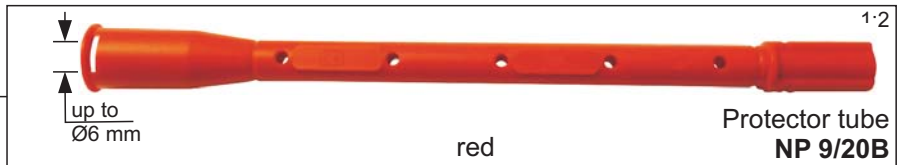
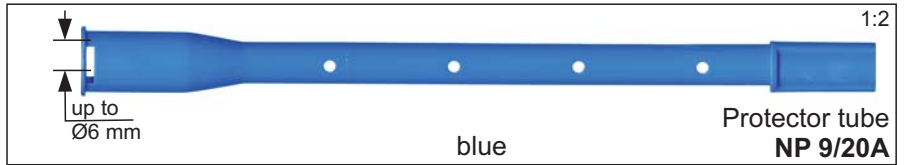

Fan Retractor

5 mm Fan Retractor complete, **curved**, syringe type

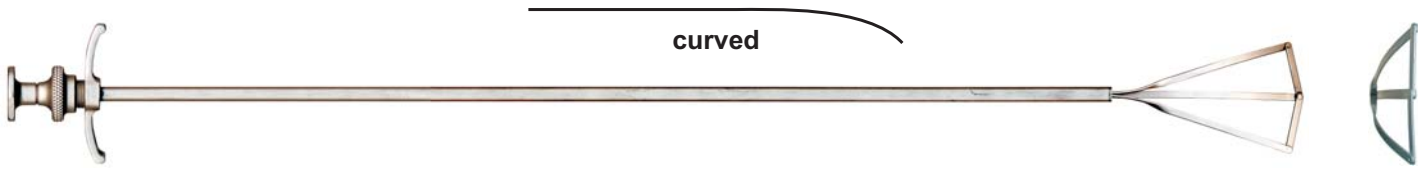

LRB-005-450

5 mm Fan Retractor complete, **straight**, syringe type

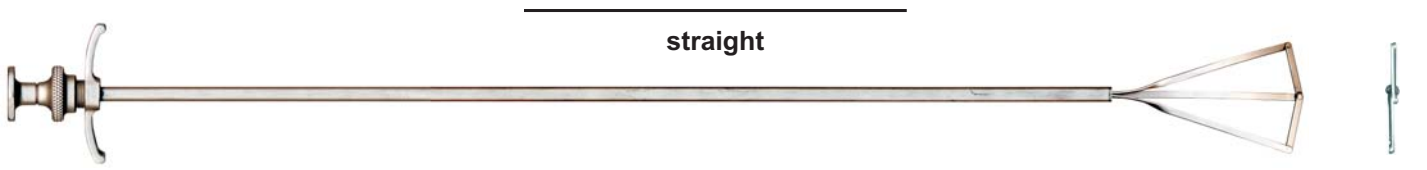

LRA-005-450

5 mm Fan, **curved**, syringe type

1:2



curved

NP 10/5

5 mm Fan, **straight**, syringe type

1:2



straight

NP 10/6



Turn cap

1:1



NP 10/9

170413 NP_10

Link

all size mm

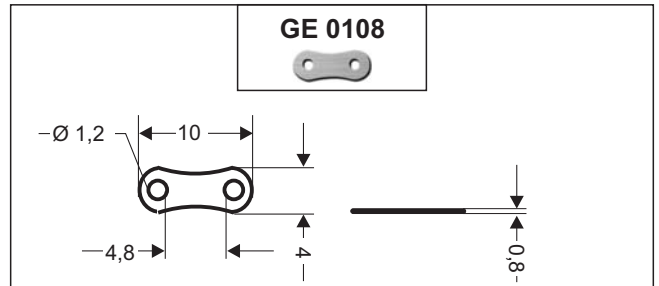
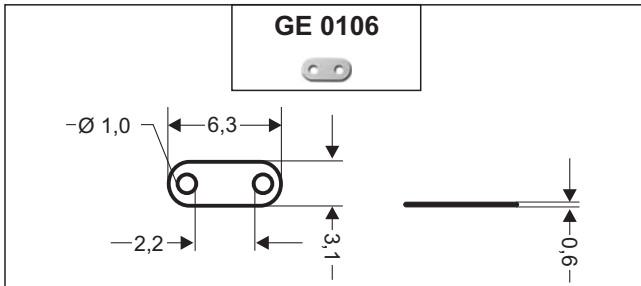
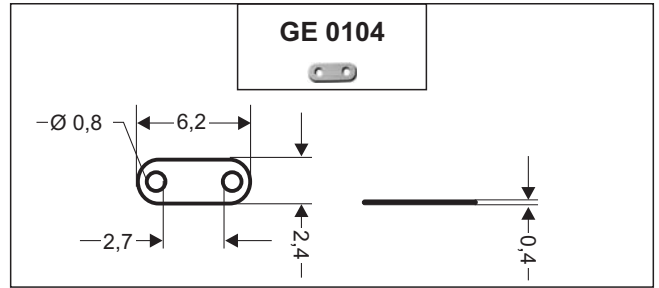
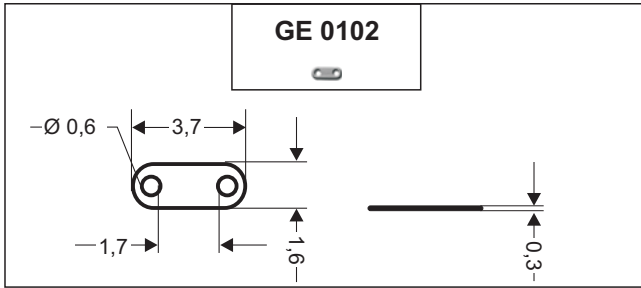
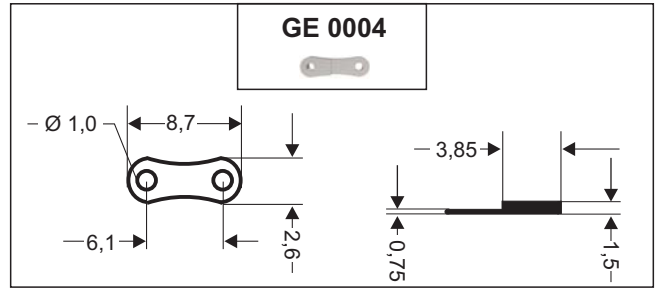
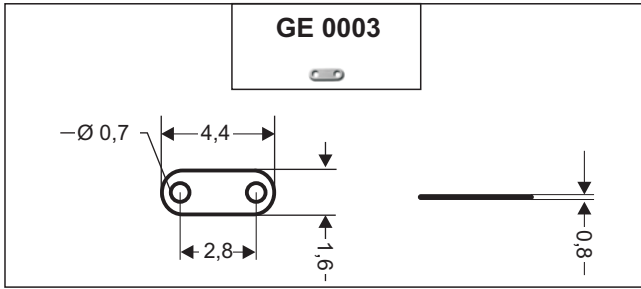
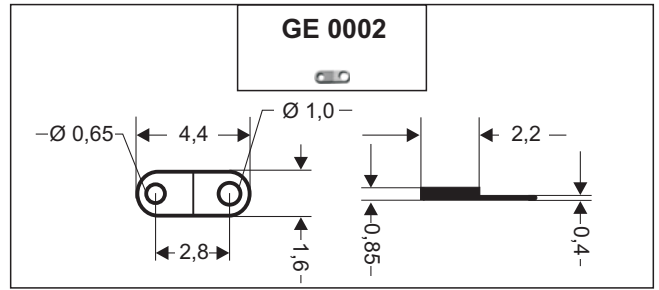
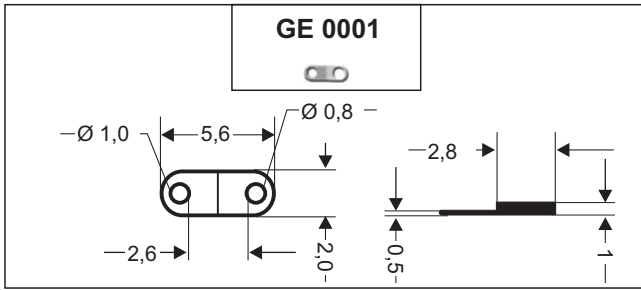

Link

all size mm

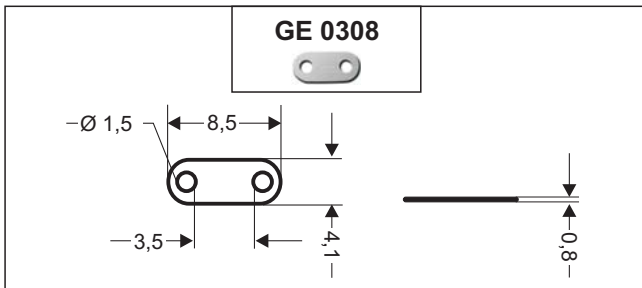
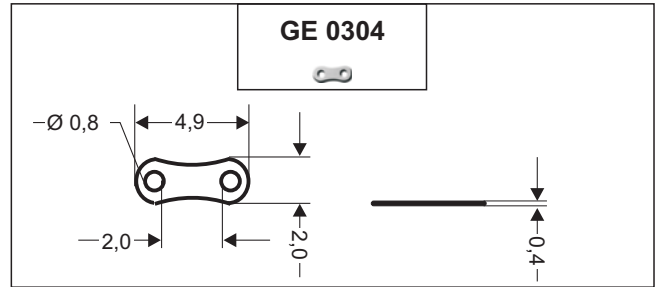
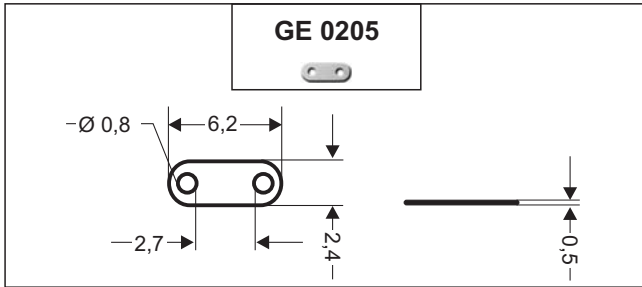
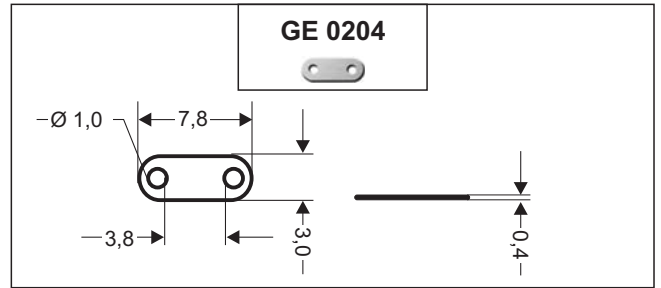
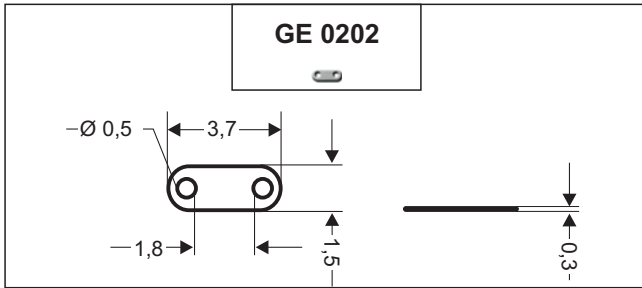

DAN - MIC - REPAIR - SYSTEMS

Instrument Tips *(see page off 1/1)*

Jaws thread M3,5 x 0,35 mm with innerstem Ø 1,50 mm

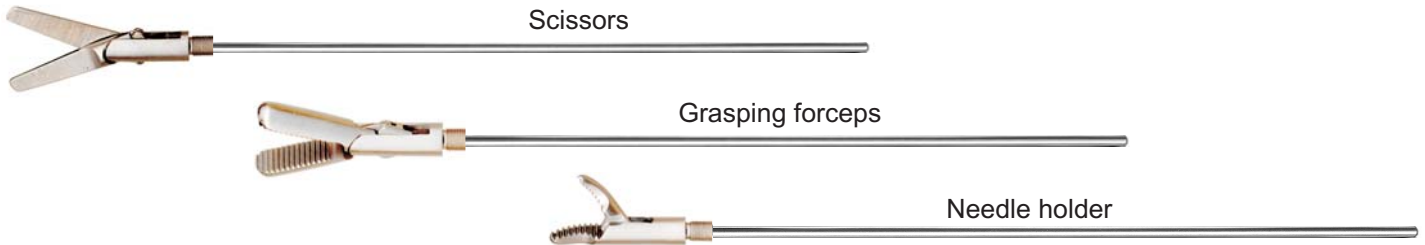

Handles

(different styles see page 6/5)



Outer tube

all sizes in length 330 mm, 350 mm or 450 mm

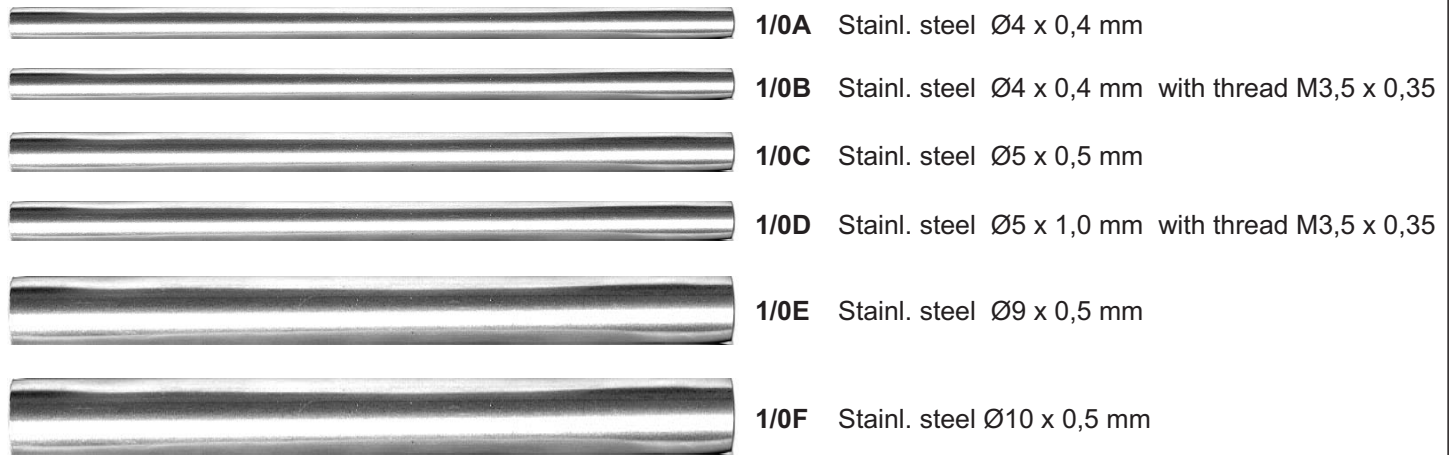

Tube insulation

all sizes in length 330 mm, 350 mm or 450 mm

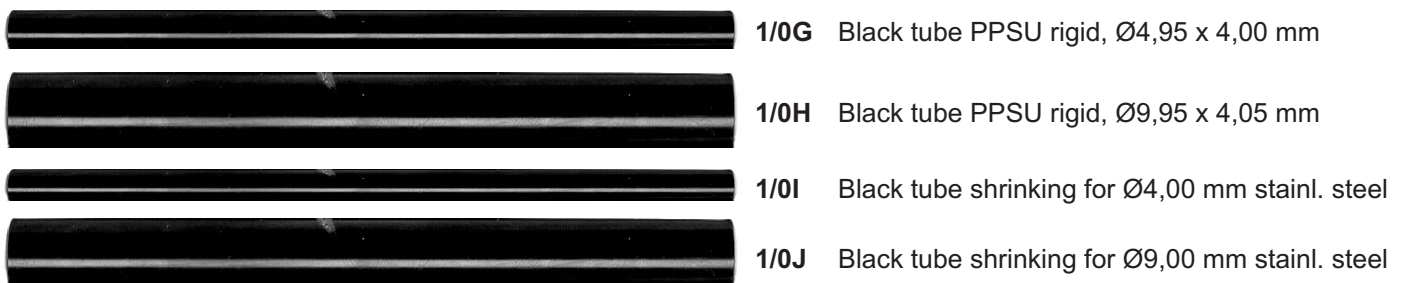

Endoscopy economy line Interchangeable easy clean system

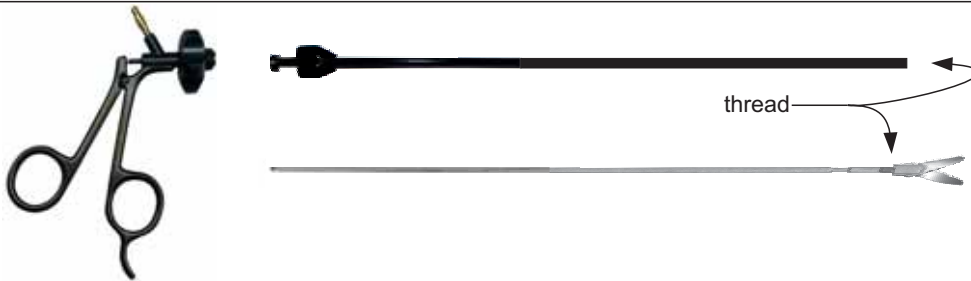

Grasping Forceps



Grasping Forceps
double action

1/10



Grasping Forceps
serrated
with long cup
double action

1/11A



Grasping Forceps
serrated
with short cup
double action

1/11B



Grasping Forceps
serrated
dolphin jaws
double action

1/12A
with long cup

1/12C
with short cup

1/12A



Grasping Forceps
serrated
dolphin jaws
with short cup
double action

1/12AA



Grasping Forceps
serrated
conical jaws
with short cup
double action

1/12B



Grasping Forceps
serrated
conical jaws
with long cup
double action

1/12BA



Dissecting Forceps
delicate
conical jaws
double action

1/13



Grasping Forceps
blunt
double action

1/14A
not serrated (like picture)

1/14B
serrated



Biopsy Cup
with thorn

1/15A
single action

1/15B
double action



Biopsy Cup
without thorn
double action

1/16

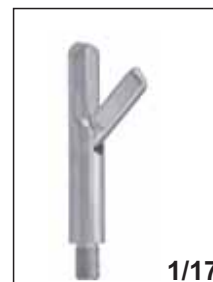

Biopsy Punch
without thorn
single action

1/17



Spoon Forceps
single action
Ø10 mm

1/18A
long cup

1/18B
short cup



Grasping Forceps
ALLIS
with 2 + 4 teeth
double action

1/19A



Grasping Forceps
ALLIS
with 2 + 4 teeth
single action

1/19AA

030817 1_01-A

© 2017 copyright by **DANmed** 1/1-A

Grasping Forceps



Grasping Forceps ALLIS
with 3 + 4 teeth
double action

1/19B



Grasping Forceps ALLIS
with 2 + 4 teeth
smooth
double action

1/19C



Grasping Forceps
serrated
with window
double action

1/20



Grasping Forceps MARYLAND
double action
jaws 13,5 mm

1/21A



Grasping Forceps MARYLAND
double action
jaws 18,0 mm
Ø5 mm

1/21B



Grasping Forceps MARYLAND
double action
jaws 18,0 mm
Ø10 mm

1/21C



Grasping Forceps MARYLAND
JARIT-style
double action

1/21D

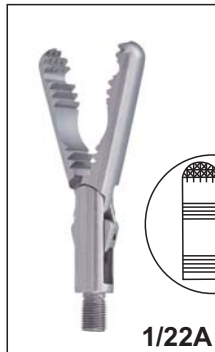

Grasping Forceps DUAL-CUP
JARIT-style
double action

1/22A

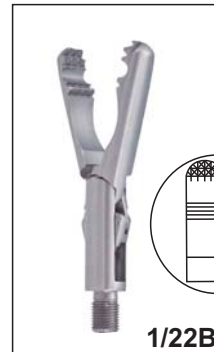

Grasping Forceps DUAL-CUP
Snowden &
Pencer style
double action

1/22B



Grasping Forceps DUAL-CUP
double action

1/22C

old order-no: 1/22



Grasping Forceps
Atrauma
with window
double action

1/23



Grasping Forceps
Atrauma
with 2 row of teeth
double action

1/24



Grasping Forceps DORSEY
with window
double action
straight

1/25A

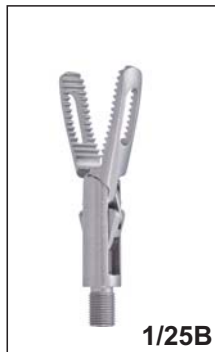

Grasping Forceps DORSEY
with window
double action
curved

1/25B



Claw Forceps
single action
2 x 3 teeth
Ø5 mm

1/26B

140415 1_01-B1

© 2016 - copyright by DANmed

1/1-B1

Grasping Forceps



Claw Forceps
single action
2 x 3 teeth
Ø10 mm

1/26A



Grasping Forceps
sharp
crosswise teeth
jaws 18,0 mm
double action

1/27A



Grasping Forceps
sharp
serrated
jaws 18,0 mm
double action

1/27B



Grasping Forceps
with 1 + 2 teeth
serrated

1/28A
single action

1/28B
double action



Grasping Forceps
double action

1/29



Dissecting and Grasping Forceps
double action
with window

1/30A



Dissecting and Grasping Forceps
double action
without window

1/30B



Fundus Grasping Forceps
double action
pull to close

1/31A



Fundus Grasping Forceps
single action
push to close

1/32



Fundus Grasping Forceps
single action
pull to close

1/33



Retraction Grasping Forceps
double action
pull to close

1/34A



Retraction Grasping Forceps
single action
push to close

1/34B



Retraction Grasping Forceps
single action
pull to close

1/34C



Retraction Grasping Forceps
double action
push to close

1/34D

140415 1_01-B2

Grasping Forceps



Atrau-ALLIS Grasping Forceps
double action

1/35



Dissecting and Grasping Forceps
double action

1/36



Retrograde Grasping Forceps
double action

1/37



Mixer-Spreader-Dissector
double action
Ø 5 mm

1/38



Mixer-Spreader-Dissector
double action
Ø 10 mm

1/39



Babcock Grasping Forceps
double action

1/40A
Ø 5 mm

1/40AA
Ø 5 mm
longitudinally
serrated

1/40B
Ø 10 mm



Grasping Forceps Johan
single action
with window
pull to close

1/41A



Grasping Forceps Johan
single action
with window
push to close

1/41B



Grasping Forceps
double action
with window

1/42



Grasping Forceps Schertl
double action
with window

1/43



Grasping Forceps Duval
double action

1/44



Grasping Forceps Hunter Bowel
22 mm Jaw
double action
with window

1/45

Grasping Forceps



1/46

**Grasping Forceps
De Bakey**
45 mm Jaw
double action



1/47

**Grasping Forceps
Dual-Cup**
double action



1/48A

**Grasping Forceps
Tenaculum**
round
double action



1/48B

**Grasping Forceps
TENACULUM**
flat
double action



1/48C

**Grasping Forceps
TENACULUM**
double action
Ø10 mm



1/48D

**Grasping Forceps
TENACULUM**
flat
double action
Ø10 mm



1/49

**Grasping Forceps
Atrau-Allis**
double action



1/50

**Grasping Forceps
Bowel**
double action
with window



1/51

**Grasping Forceps
Mc Kearnan**
double action
with window



1/52

**Grasping Forceps
DeBakey**
double action

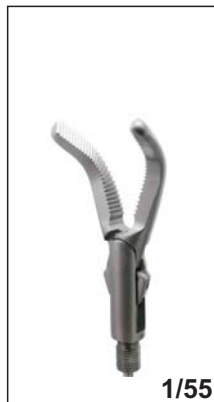

1/55

**Grasping Forceps
Mixer**
double action
Ø10 mm

070915 1_01-C2

Scissors



Supercut Scissors
single action
serrated lower blade



Peritoneal Scissors
straight
single action



Hook Scissors
single action
short



Hook Scissors
single action
long



METZENBAUM Scissors
straight
double action



METZENBAUM Scissors
curved
double action



METZENBAUM Scissors
straight
double action
11,5 mm length



METZENBAUM Scissors
curved
double action
11,5 mm length



Micro Scissors
single action
straight



Micro Scissors
single action
curved



SUPERCUT Endo Scissors
double action
curved



V. MUELLER SUPERCUT Endo Scissors
double action
curved

Suture instruments



Needleholder
cross serrated
single action

3/10



Needleholder
cross serrated
with TC
single action
pull to close

3/11A



Needleholder
cross serrated
with TC
single action
push to close

3/11B



Grasping Forceps
with TC
double action

3/12A



Grasping Forceps
with TC
double action

3/12B



Needleholder
straight
with TC
single action
attachment
with tube

3/13A



Needleholder
curved right
with TC
single action
attachment
with tube

3/13B



Needleholder
curved left
with TC
single action
attachment
with tube

3/13C



Needleholder
serrated
curved left
single action

3/14

Laryngeal Instrumentation

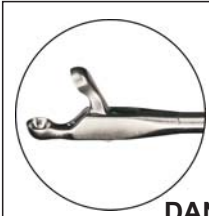

DAN-506-455



DAN-506-460



DAN-506-461

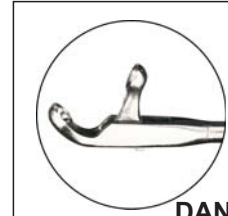

DAN-506-462



DAN-506-463



DAN-506-465

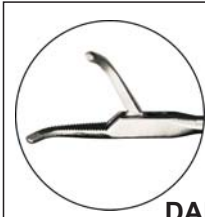

DAN-506-470



DAN-506-471



DAN-506-472



DAN-506-475



DAN-506-476



DAN-506-477



DAN-506-478



DAN-506-479

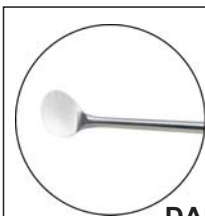

DAN-506-665



DAN-506-680



DAN-506-802



DAN-506-804



DAN-506-806



DAN-506-808



DAN-506-810



DAN-506-812



DAN-506-814



DAN-506-816

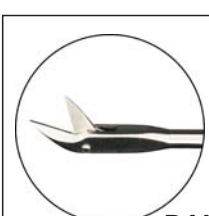

DAN-506-818

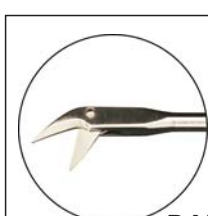

DAN-506-820

These parts No#
are similar to
Pilling:
"push to close"
Ask also for
"pull to close"

270115 1_01-F1

Laryngeal Instrumentation



These parts No#
are similar to
Pilling:
“push to close”
Ask also for
“pull to close”

Spare Parts usable for Trocars

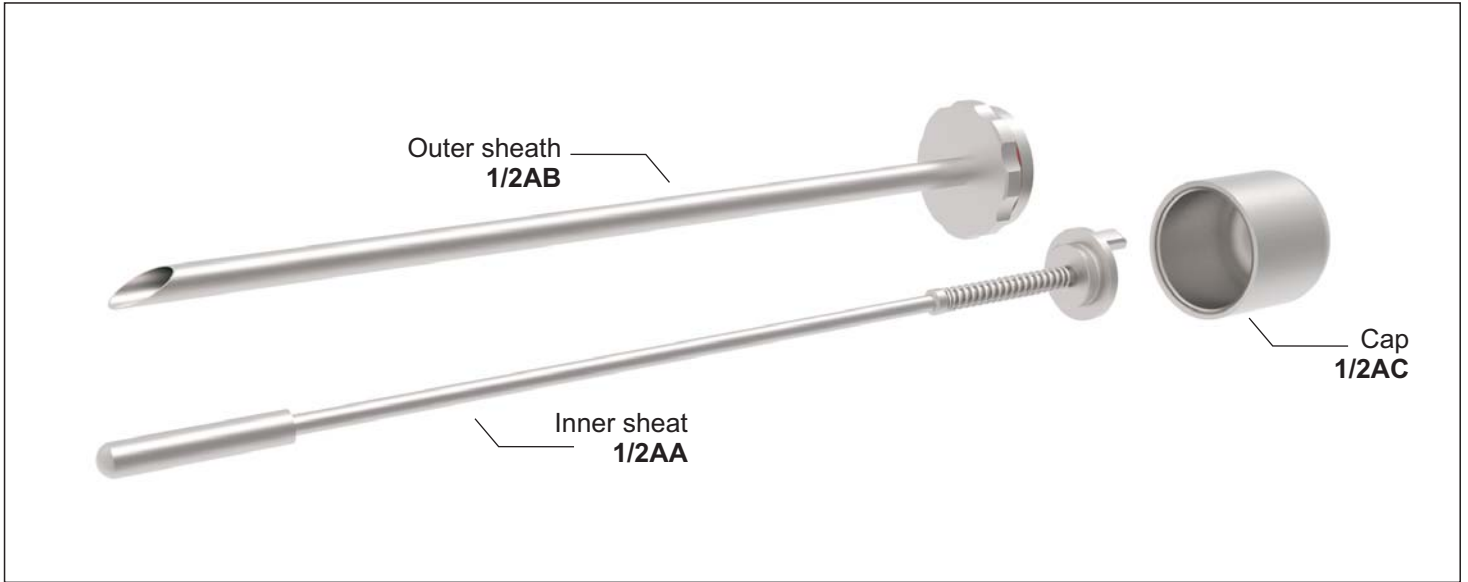

Ø3.5 mm Endoscopic instrumentation jaw complete with tube



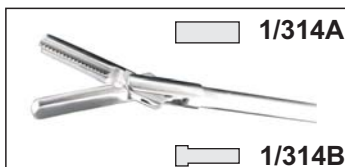
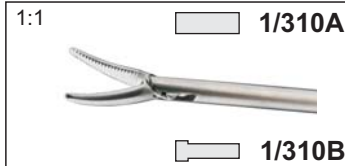
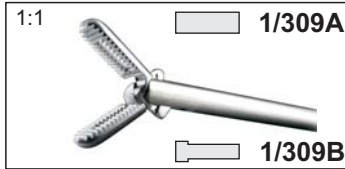



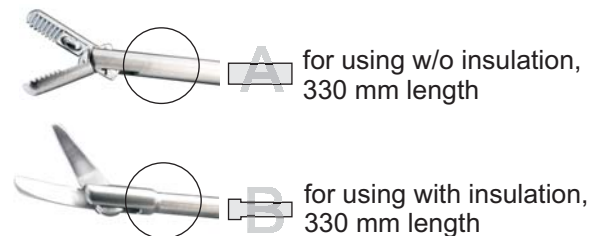
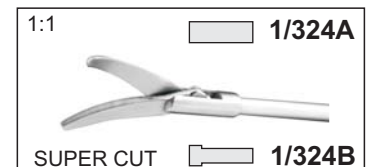
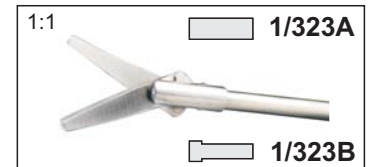
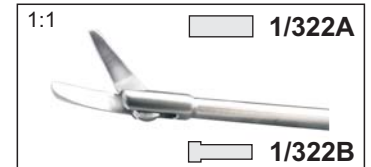
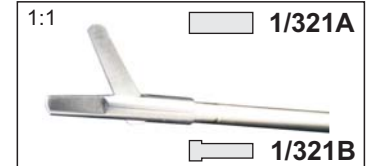
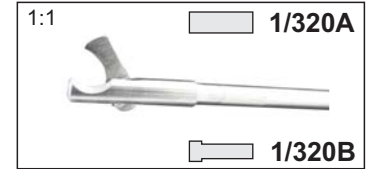
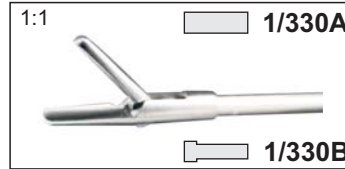





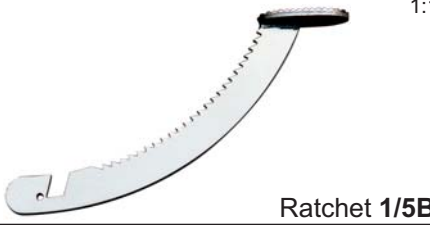
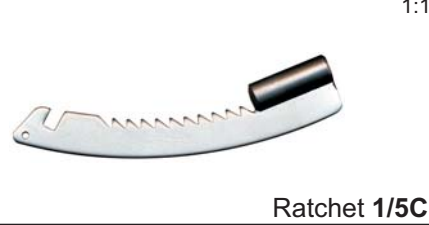

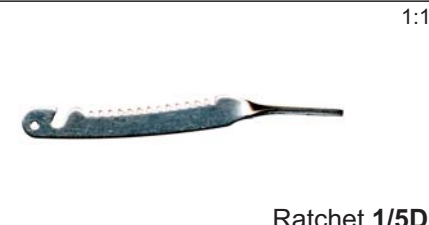



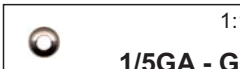













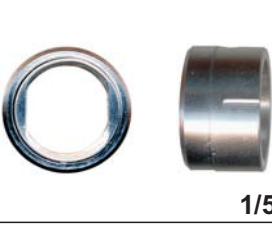

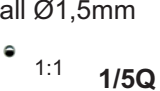

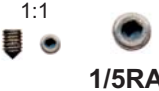
Grasping Forceps



Scissors

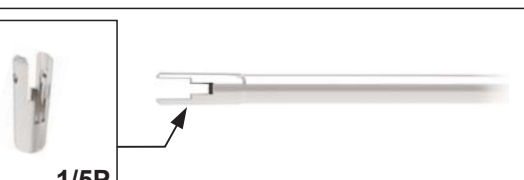

DAN - Mic - Repair System

 1:1 Spring 1/5A	 1:1 Spring 1/5AA	 1:1 Ratchet 1/5B	 1:1 Ratchet 1/5C
 1:1 Ratchet 1/5BA	 1:1 Ratchet 1/5D	 1:1 1/5EE	 1:1 1/5EF
 1:1 1/5F	 1:1 1/5GA - GI	 1:1 1/5GH	 1:1 1/5GK
 1:1 1/5HB		 1:1 (main), 3:1 (detail) Innerstem 450 mm length 1/5H	
 1:1 (main), 3:1 (detail) Innerstem 450 mm length 1/5HA		 1:1 (main), 3:1 (detail) Innerstem 450 mm length 1/5 I	
			
 1:1 1/5J	 1:1 1/5K	 1:1 1/5KN	 1:1 1/5L
 1:1 1/5M	 1:1 1/5O		 1:1 1/5OO
 1:1 1/5OP		 1:1 Ball Ø1,5mm 1/5Q	 1:1 Ball Ø2,0mm 1/5QA
 1:1 Ball Ø2,5mm 1/5QB	 1:1 1/5RA	 1:1 1/5RAA	 1:1 1/5RB
 1:1 1/5RBB	 1:1 1/5RC	 1:1 1/5T	 1:1 1/5U
 1:1 1/5V	 1:1 1/5S		 1:1 1/5P
 1:1 NP 3-3A17B w/o locking mechanism			

270116 1_05

© 2016 - copyright by **DANmed**

1/5

Ceramic tip

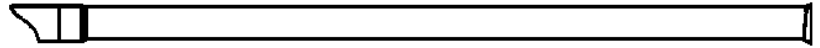

<p>1/6PA</p>	<p>1/6PB</p>	<p>1/6PC</p>
<p>1/6PD</p>	<p>1/6PE</p>	<p>1/6PF</p>
<p>1/6PG</p>	<p>1/6PH</p>	<p>1/6PJ</p>
<p>1/6PK</p>	<p>1/6PL</p>	<p>1/6PM</p>
<p>1/6PO</p>	<p>1/6PP</p>	

190713 1_06-1

Ceramic tip

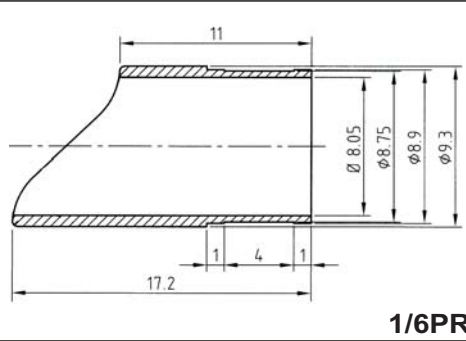
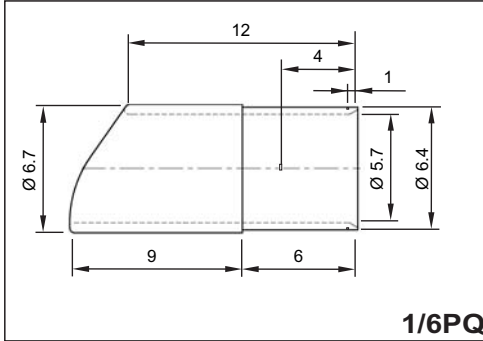
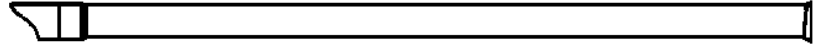

Special adhesive for ceramic tip



Size: 4g = **1/6EPO4G**
Size: 226g = **1/6EPO226G**
Size: 454g = **1/6EPO454G**

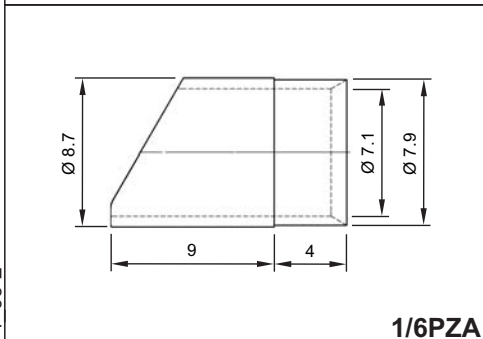
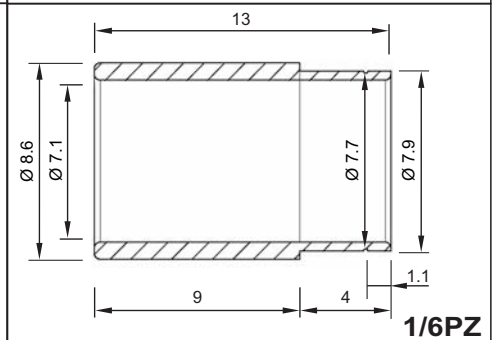
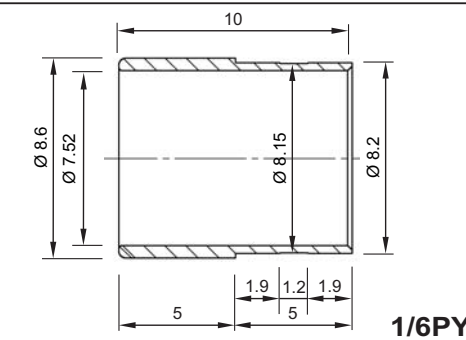
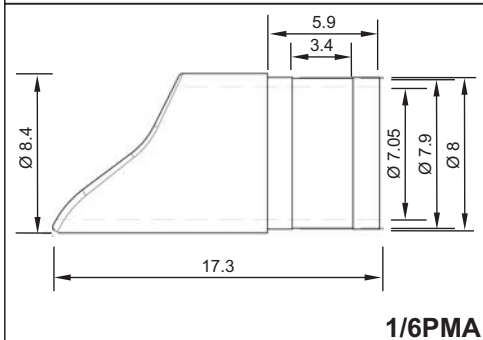
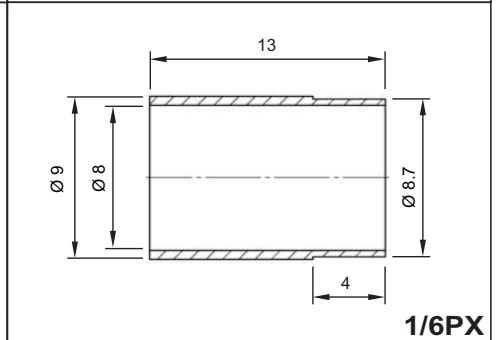
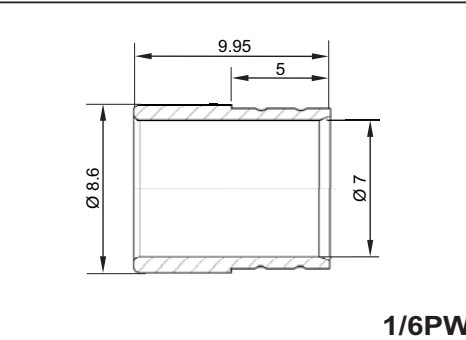
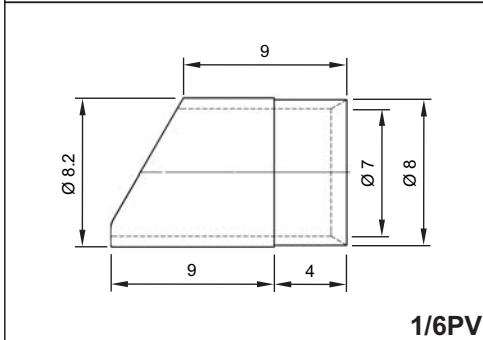
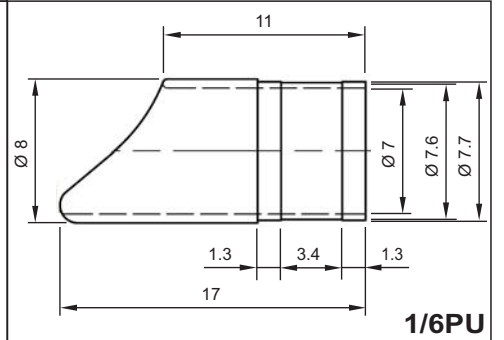
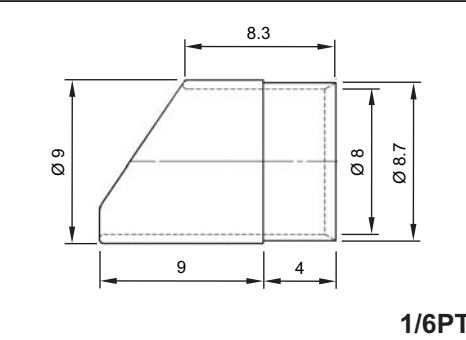
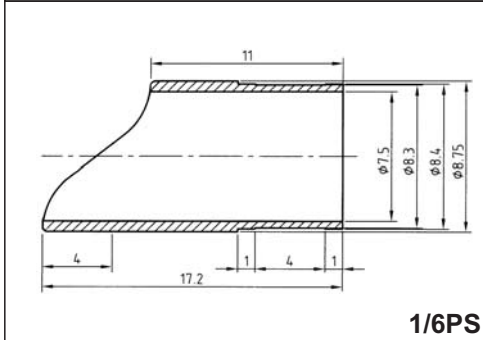

110411_1_06-2

Ceramic tip usable for OLY



24 CH

Ref#: A2641



1:1

1/6PMA



24 CH

Ref#: A42011A



1:1

1/6PU



26 CH

Ref#: A22042A



1:1

1/6PS

Ceramic tip usable for ST

Usable for Ref#: 26040XA; 27040 XB / XC / XD
27050SL / SM / XA / XB

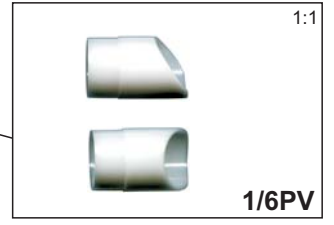

Usable for Ref#: 27050 XA / 26050 XA / 27040XA **for use with 26 CH outer sheaths**

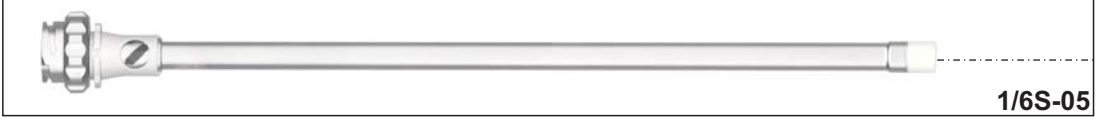
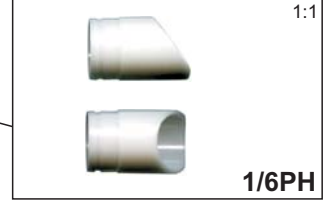

Usable for Ref#: 27050 XB / 26050 XB / 27040XB **for use with 28 CH outer sheaths**



Usable for Ref#: 27142 BZ; 27141 BO

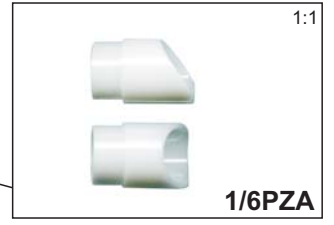

080715 1_06-3B

Ceramic tip usable for ACMI

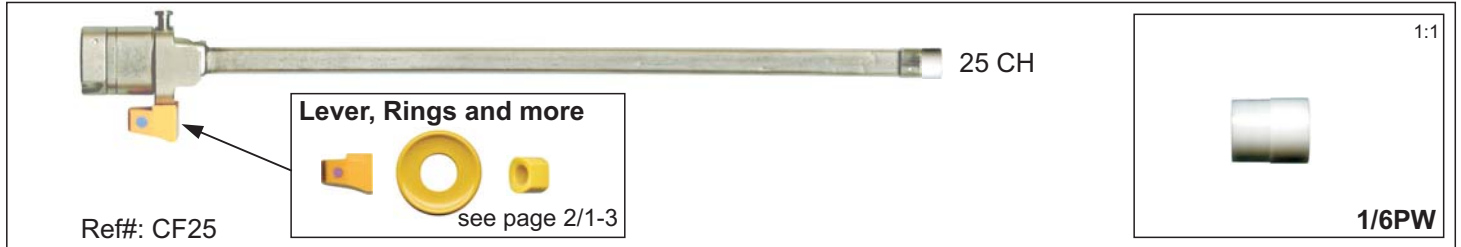

240310 1_06-3C

© 2016 copyright by **DANmed**

1/6-3C

Biopsy Forceps Repairs

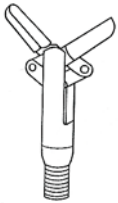

2/0A

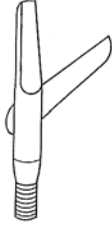

2/0B

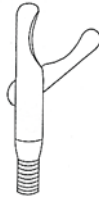

2/0C

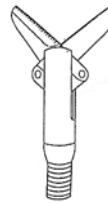

2/0D

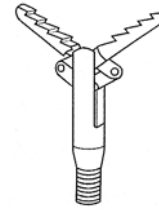

2/0E

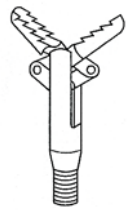

2/0F

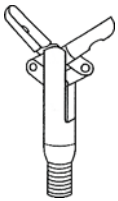

2/0G

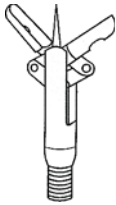

2/0H

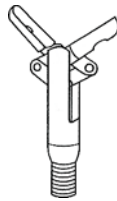

2/0I

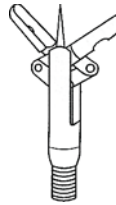

2/0J

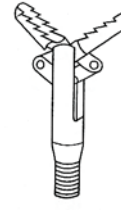

2/0K

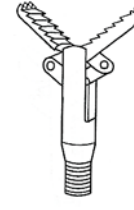

2/0L

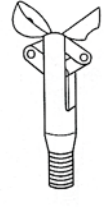

2/0M

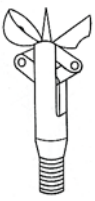

2/0N

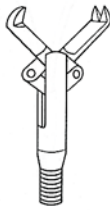

2/0O

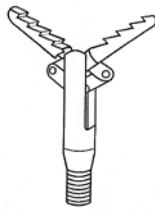

2/0P

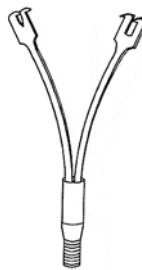

2/0Q

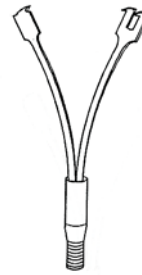

2/0R

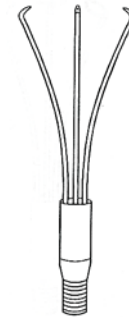

2/0S

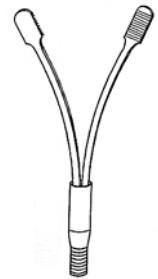

2/0T

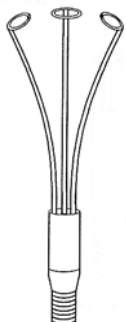

2/0U

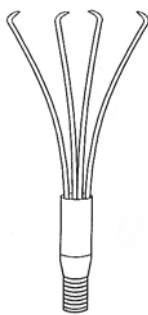

2/0V



2/0W

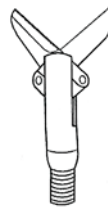

2/0X

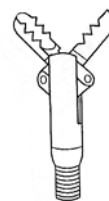

2/0Y

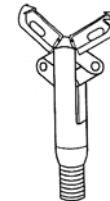

2/0Z

080803 2_00

© 2016 copyright by DANmed

2/0

Biopsy Forceps Repairs

We offer all different rough jaws

2/1A

6/8A

6/8M

Handle see page 6/5

Handle see page 6/5

Antikink sheath 1:1

3.3 x 0.50 x 50mm
100mm length possible **2/1D**

3.6 x 0.70 x 50mm
100mm length possible **2/1E**

3.7 x 0.60 x 50mm
100mm length possible **2/1F**

Ø2 - Ø6
(see pricelist) 1:1

2/1P-(x)

ØOD1mm → ØOD2mm

short

long

121016 2_01

Spare Parts usable for ACMI

Gynecologic Resectoscope Accessories



Handle usable for ACMI

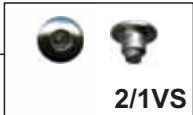

Handel
2/1V

Alligator Forcep s/a



Ø1,6 mm/5Fr. length 32cm **2/2VA320**
 Ø1,6 mm/5Fr. length 42cm **2/2VA420**
 Ø2,3 mm/7Fr. length 32cm **2/1VA320**
 Ø2,3 mm/7Fr. length 42cm **2/1VA420**

Punch Biopsy Forcep s/a



Ø2,3 mm/7Fr. length 32cm **2/1VB320**
 Ø2,3 mm/7Fr. length 42cm **2/1VB420**

Scissor s/a



Ø1,6 mm/5Fr. length 32cm **2/2VC320**
 Ø1,6 mm/5Fr. length 42cm **2/2VC420**
 Ø2,3 mm/7Fr. length 32cm **2/1VC320**
 Ø2,3 mm/7Fr. length 42cm **2/1VC420**

Cup Forcep d/a



Ø1,6 mm/5Fr. length 32cm **2/2VD320**
 Ø1,6 mm/5Fr. length 42cm **2/2VD420**



Ø3,3 mm/10Fr. length 35cm **2/1VE350F**



Ø2.6 mm/8Fr. length 35cm **2/1VA350F**



120617_2_01-2

Spare Parts usable for ACMI

Optical Forceps

Jaw assembly



2/1XK

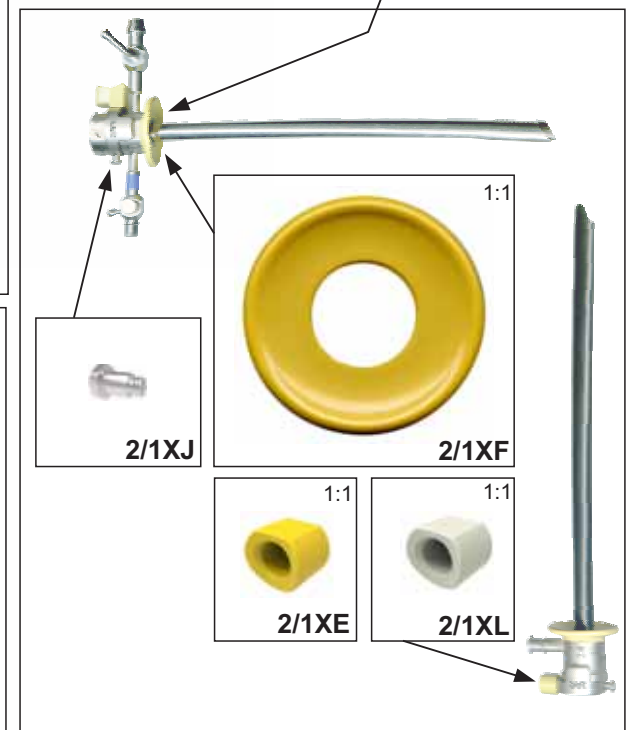

Lever

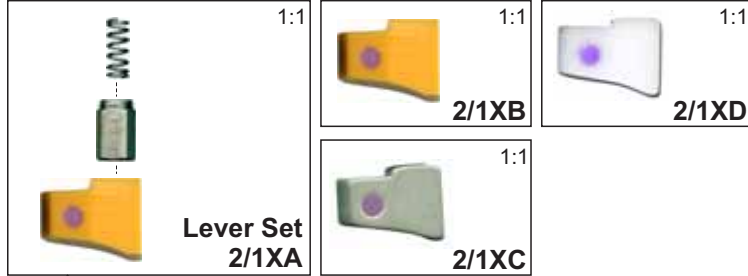

Lever Set
2/1XA

2/1XB

2/1XD

2/1XC

2/1XJ

2/1XF

2/1XE

2/1XL



2/1XG

Tungsten carbide insert / Diamond ground

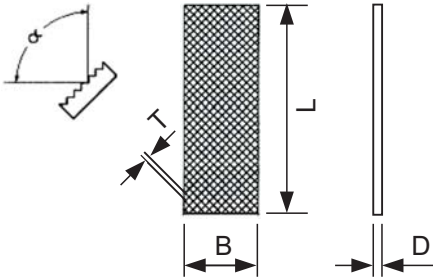
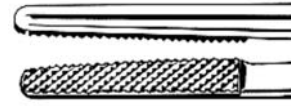

L mm	B mm	D mm	T mm
8	2	0,3 - 0,6	0,2 - 0,5
10	3,5	0,3 - 0,6	0,2 - 0,5
12	2	0,3 - 0,6	0,2 - 0,5
12	3,5	0,3 - 0,6	0,2 - 0,5
13	3	0,3 - 0,6	0,2 - 0,5
13	4	0,3 - 0,6	0,2 - 0,5
16	6	0,3 - 0,6	0,2 - 0,5
17	3,5	0,3 - 0,6	0,2 - 0,5
20	6	0,3 - 0,6	0,2 - 0,5
20	8	0,3 - 0,6	0,2 - 0,5

Q: 60° bzw. 75° beidseitig glatt, in allen Stärken D = 0,30 bis 0,65

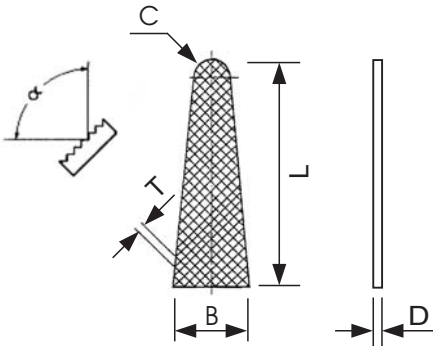

L mm	B mm	D mm	C mm	T mm
11	5,5	0,3 - 0,6	1,25	0,2 - 0,5
13	4	0,3 - 0,6	1,50	0,2 - 0,5
15	5	0,3 - 0,6	1,25	0,2 - 0,5
15	6	0,3 - 0,6	1,75	0,2 - 0,5
17	5,5	0,3 - 0,6	1,50	0,2 - 0,5
19	6	0,3 - 0,6	1,75	0,2 - 0,5

Q: 60° bzw. 75° beidseitig glatt, in allen Stärken D = 0,30 bis 0,65



Surfacing products

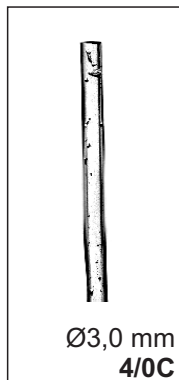
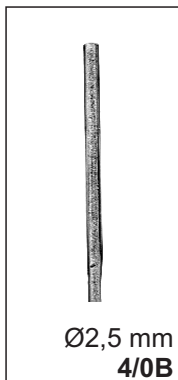
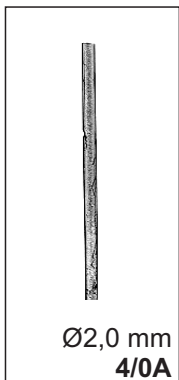

TC- Needleholder insert

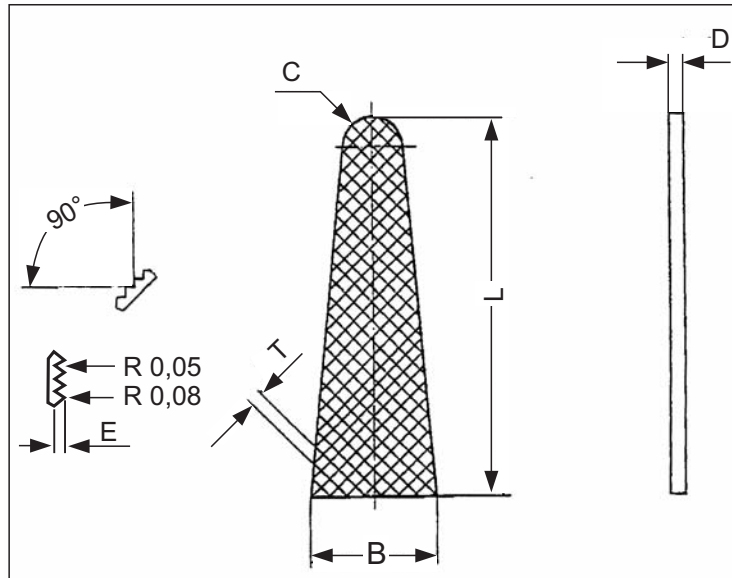

REF.	L mm	B mm	C mm	T mm	E mm	D mm
T/21836-02	7,50	2,90	1,30	0,40	0,15	0,50
T/21836-01	9,00	5,30	1,30	0,40	0,15	0,60
T/21836-08	13,00	3,60	0,75	0,50	0,20	0,50
T/21836-06	15,00	5,10	1,75	0,40	0,15	0,65
T/21836-12	15,00	4,80	1,20	0,40	0,15	0,70
T/21836-05	16,00	5,20	1,40	0,50	0,20	0,70
T/21836-10	16,00	5,20	1,40	0,40	0,15	0,70
T/21836-03	17,00	6,50	1,75	0,50	0,20	0,60
T/21836-07	17,00	5,60	1,75	0,40	0,15	0,65
T/21836-09	17,00	4,50	1,20	0,50	0,20	0,70
T/21836-04	20,00	6,00	1,75	0,50	0,20	0,70
T/21836-11	20,00	6,00	1,75	0,40	0,15	0,70
T/21836-13	21,50	7,00	2,40	0,50	0,20	0,70

T 0,4 = 4200 teeth, T 0,5 = 2600 teeth

Tungsten Carbide Wire Cutting Pliers

for wires up to Ø2.5 mm

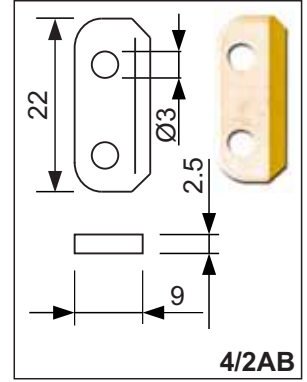
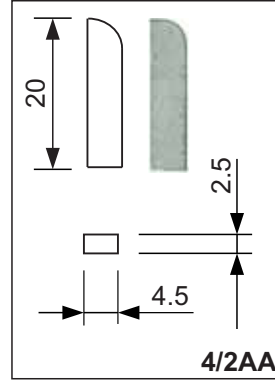
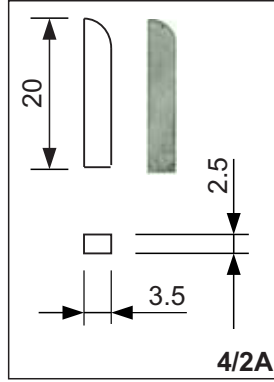

for hard wires up to Ø1.6 mm
for soft wires up to Ø2.0 mm

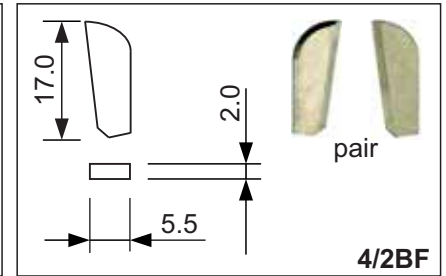
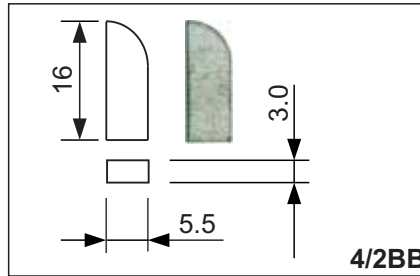
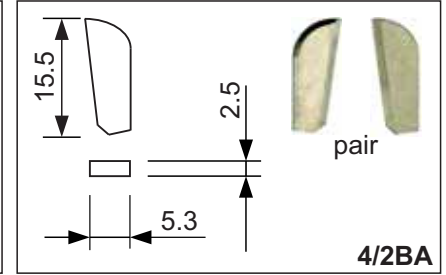
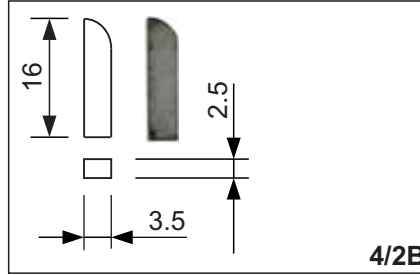

Pair TC Insert for head- and side-cutter



for hard wires up to Ø1.5 mm

for soft wires up to Ø2.0 mm

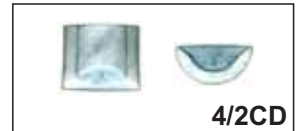

Division (mm)	order-no
0.8	4/2E
1.1	4/2F
1.3	4/2G
1.6	4/2H
1.8	4/2I
2.0	4/2J
2.4	4/2K
2.6	4/2L



060317 4_02-1A

Screws and more for Wire Cutting Pliers

for all Hercules Cutting

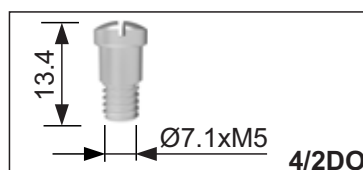
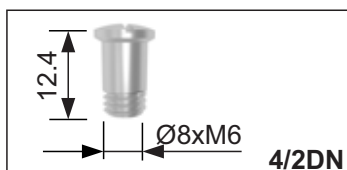
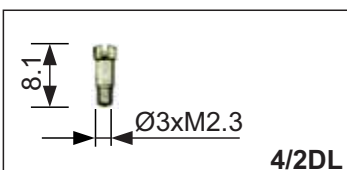
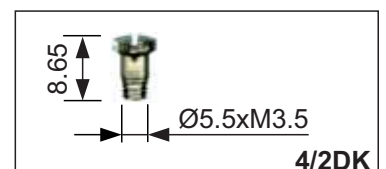
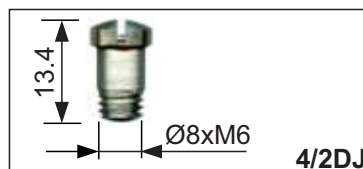
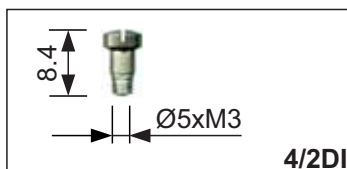
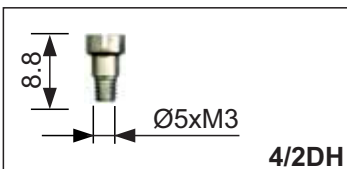
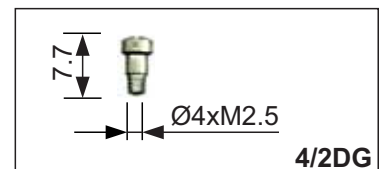
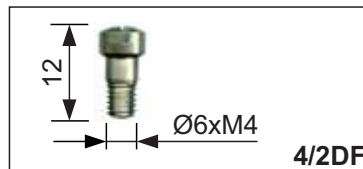
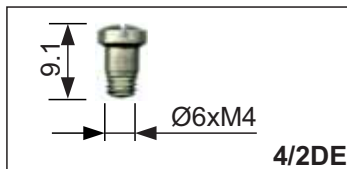
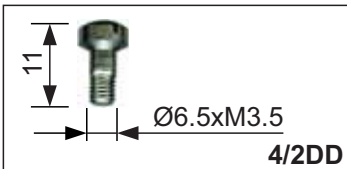
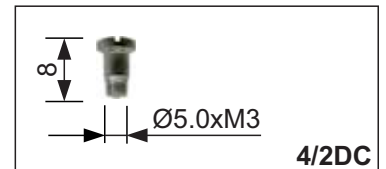
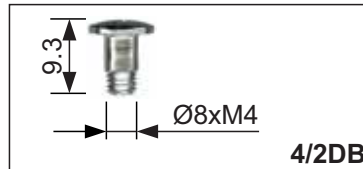
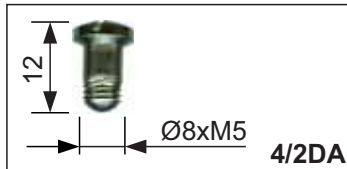
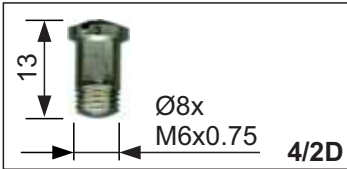

060317 4_02-1B

© 2017 copyright by DANmed 4/2-1B

Wire cutter

TC Pin Cutter
220 mm, 8 3/4"

1:5



4/2M

TC Pin Cutter
170 mm, 6 3/4"
Made in Germany

1:5



4/2N

TC Pin Cutter
170 mm, 6 3/4"
standard

1:5



51-0773-17

TC Pin Cutter
140 mm, 5 1/2"
standard

1:5



51-0773-14

TC Pin Cutter, front+lateral cut
180 mm, 7"

1:5



4/2P

Repairing head- and side- Cutter
with TC

1:5

Send old one
for repair



4/2R

Repair Exchange

1:5



4/2RE

Wire Cutter, 240 mm, 9 3/4", TC
max. cap Ø2,6mm

1:2



4/2T

Plate cutting Forcep, 185 mm, 7 1/2, TC
max. cap Ø2,0mm

1:2



4/2U

Wire cutter

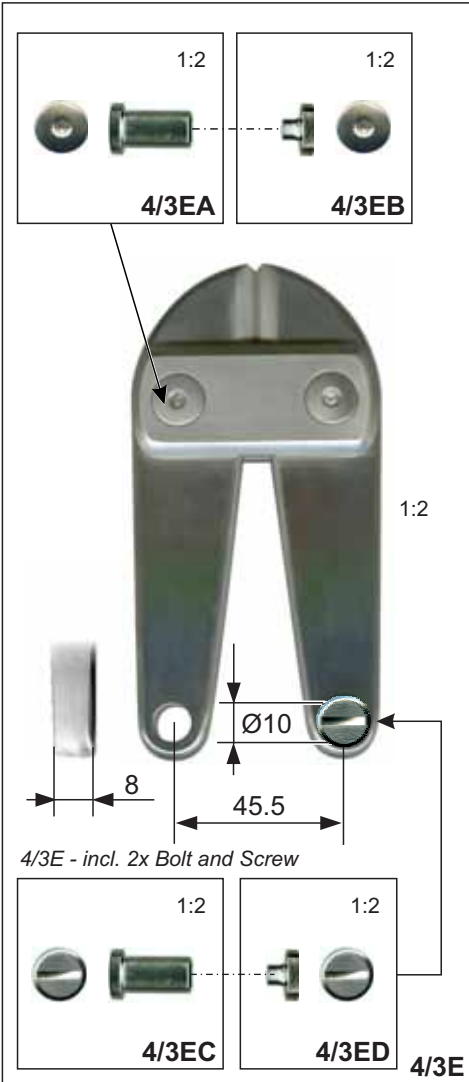
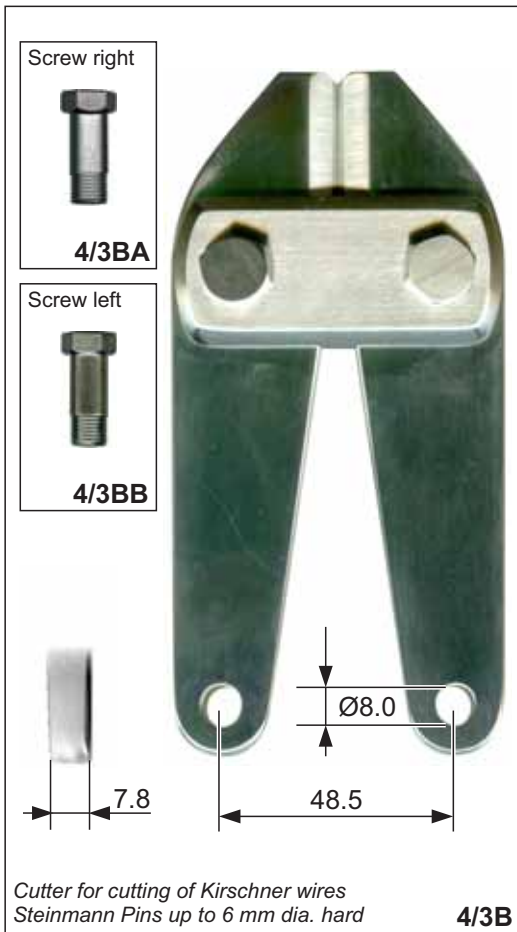
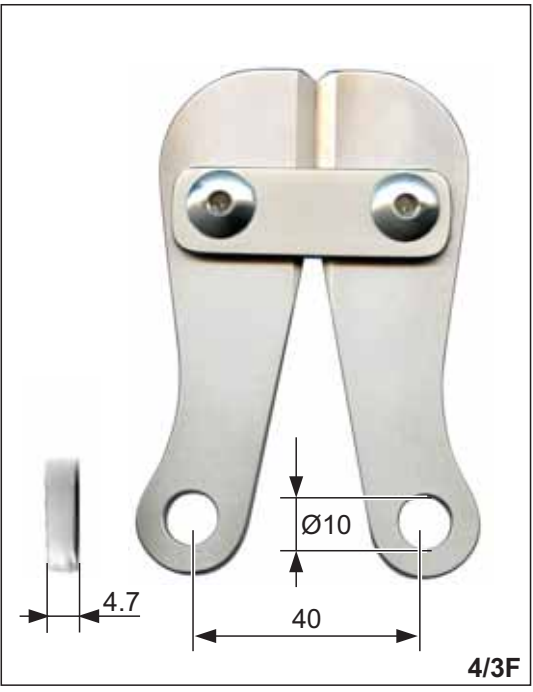
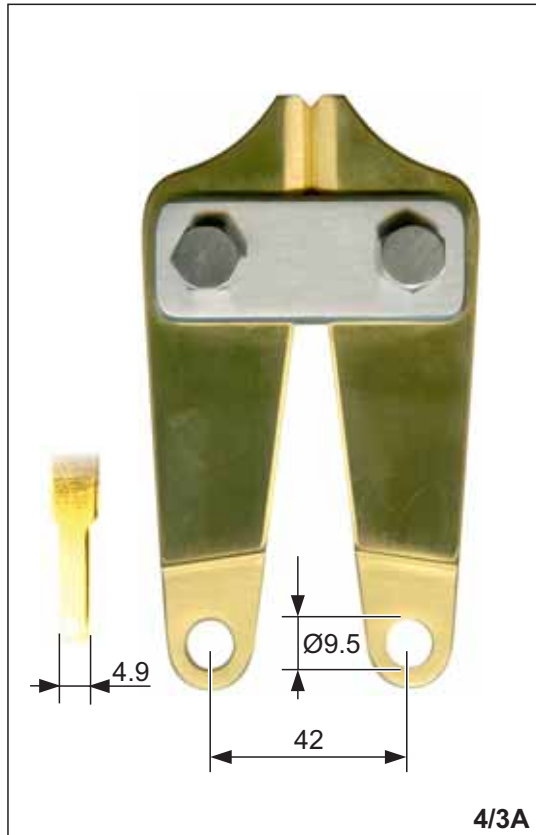

060417 4 03-1

Wire cutter

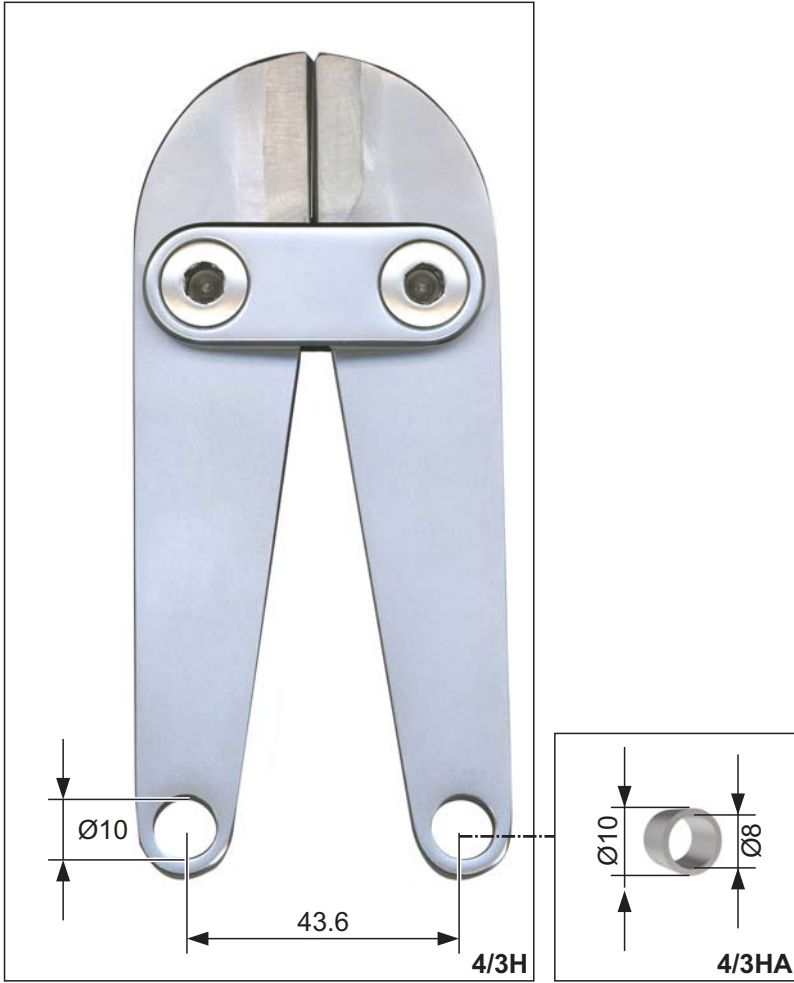

060317 4_03-2

© 2017 copyright by **DANmed**

4/3-2

Replacement silicon cap

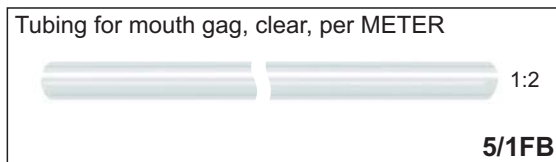
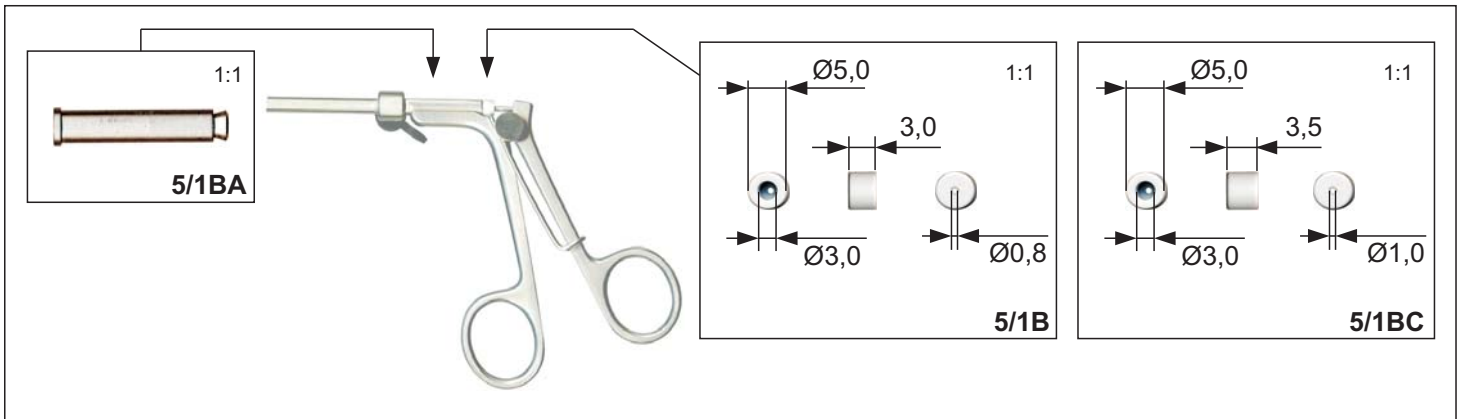
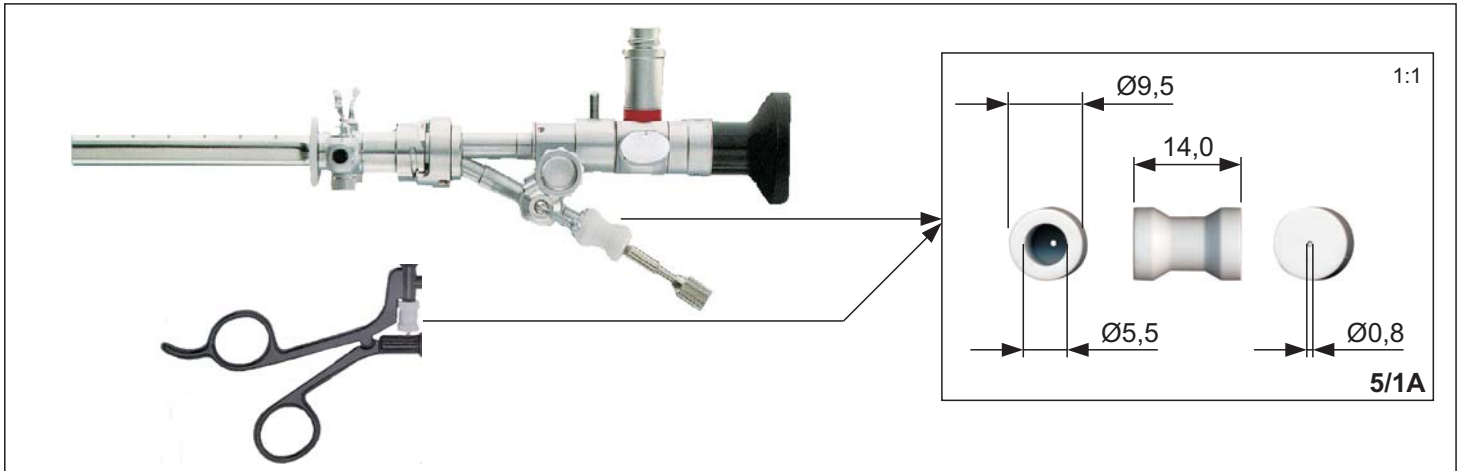

Spare Parts usable for Trocars

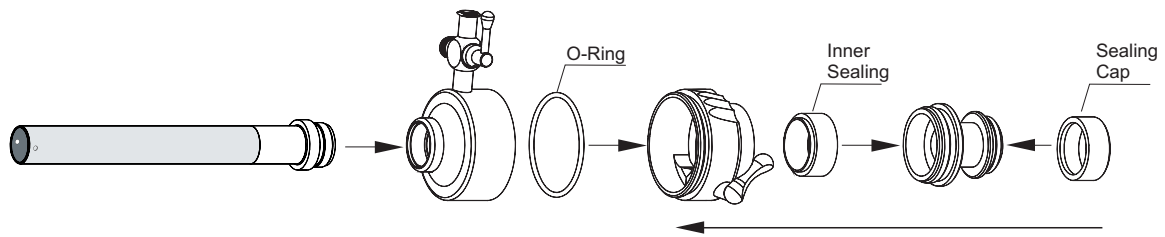

O-Ring

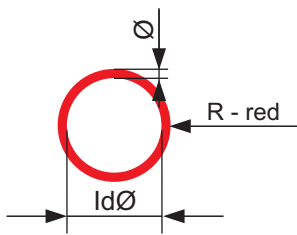

O-xxxx-xxx

Inner Sealing



Black	for Trocar Ø 3.5	LTE-035-240
Gray	for Trocar Ø 5 - Ø 8	LTE-050-140
Yellow	for Trocar Ø 10 - Ø 13	LTE-110-020
Blue	for Trocar Ø 15	LTE-150-010
Blue	for Trocar Ø 20	LTE-200-010

Sealing Cap



for Trocar Ø 3.5	LTD-000-020
for Trocar Ø 5 - Ø 5.5	LTD-010-040
for Trocar Ø 6 - Ø 6.5	LTD-020-050
for Trocar Ø 7	LTD-030-060
for Trocar Ø 8	LTD-040-070
for Trocar Ø 11 - Ø 12	LTD-050-080
for Trocar Ø 12.5	LTD-060-110
for Trocar Ø 13	LTD-070-100

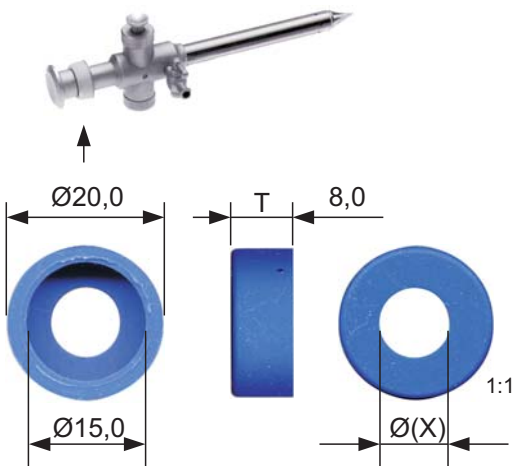

x = Ø 1,0 mm or x = Ø 2,0 mm or
 x = Ø 3,0 mm or x = Ø 4,0 mm or
 x = Ø 6,0 mm or x = Ø 8,0 mm or
 x = Ø 10,0 mm or x = Ø 12,0 mm **5/1C**

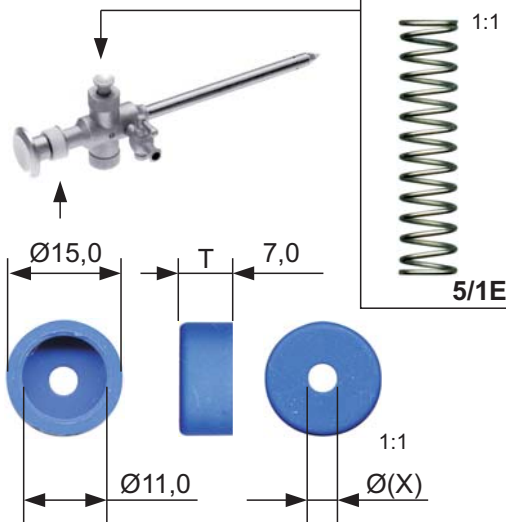

x = Ø 2,5 mm or
 x = Ø 4,0 mm **5/1D**

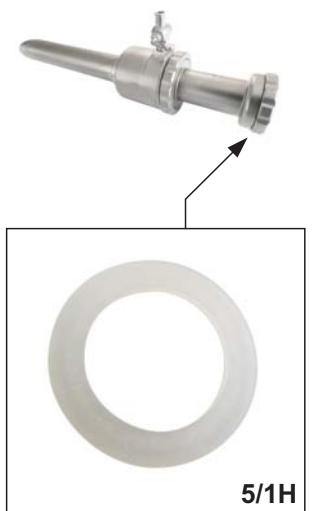

Springs / Lock /Ratchet

Retractor Ratchet Set



5/2A

Castroviejo Spring Set



1:1

5/2C

Barraquer - Lock Set

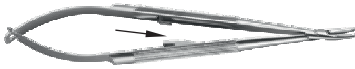

1:1



1:2

5/2E

Castroviejo Spring Sets

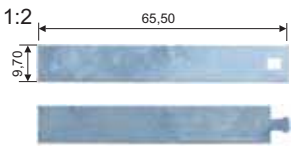

5/2GA

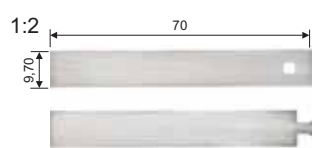

5/2GB

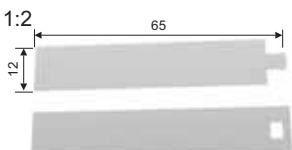

5/2GC

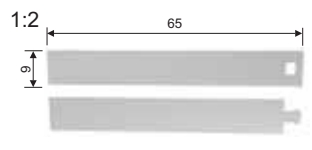

5/2GD



Forceps - Lock

Complete lock set

1:1



5/2B

only lock



5/2B-SP

only screw



1:1

5/2B-S

Castroviejo - Lock Set



1:1

5/2D

Needle holder Tube - Lock Set

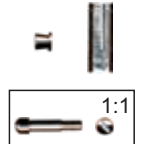

1:1

5/2F

1:1



5/2I

1:1



3 mm = 5/2J
4 mm = 5/2K
5 mm = 5/2L

1:1



5/2N

1:1



5/2O

1:1



5/2P

Catches / Springs

Applying forceps

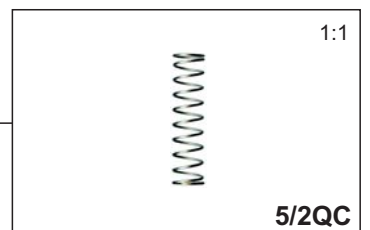
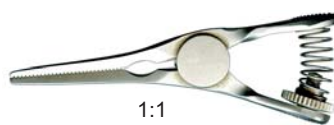
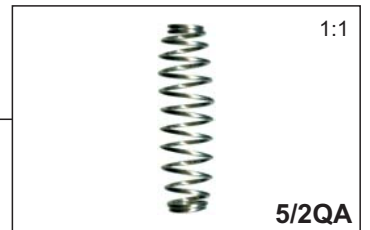
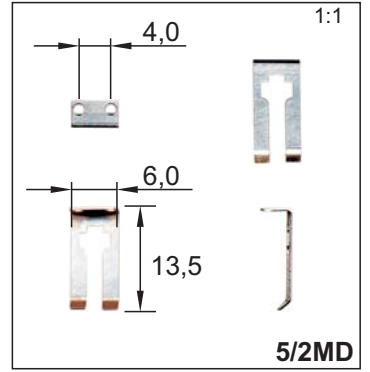
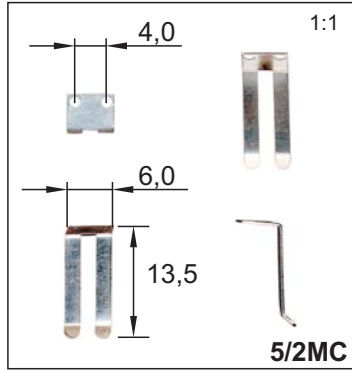
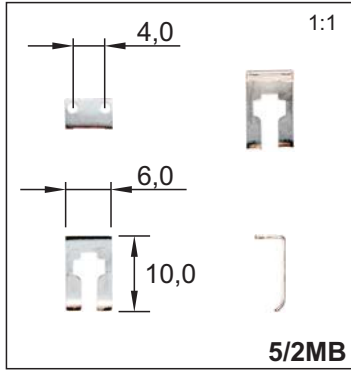
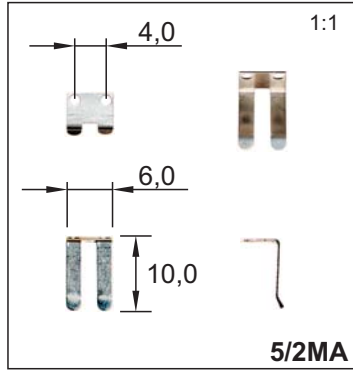
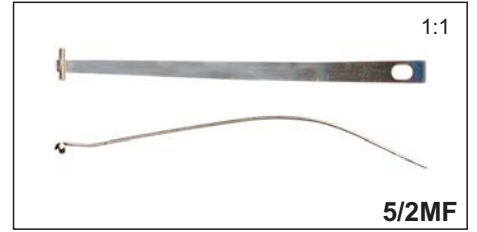

281111 5/2-2A

© 2016 copyright by **DANmed**

5/2-2A

Catches / Springs

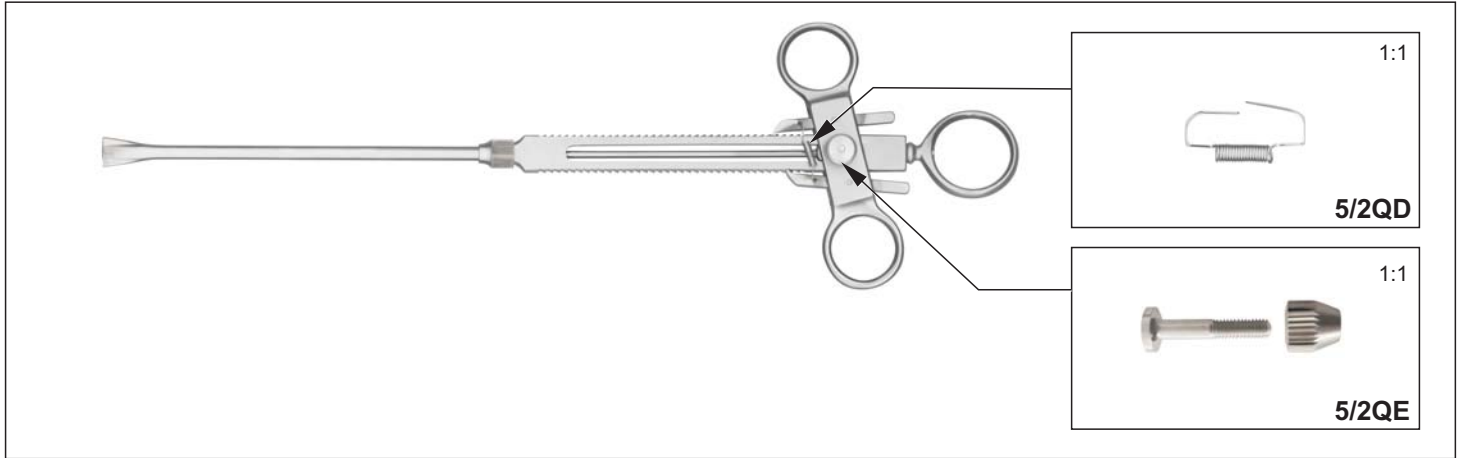

150715 5/2-2B

© 2016 copyright by **DANmed**

5/2-2B

Distance Piece

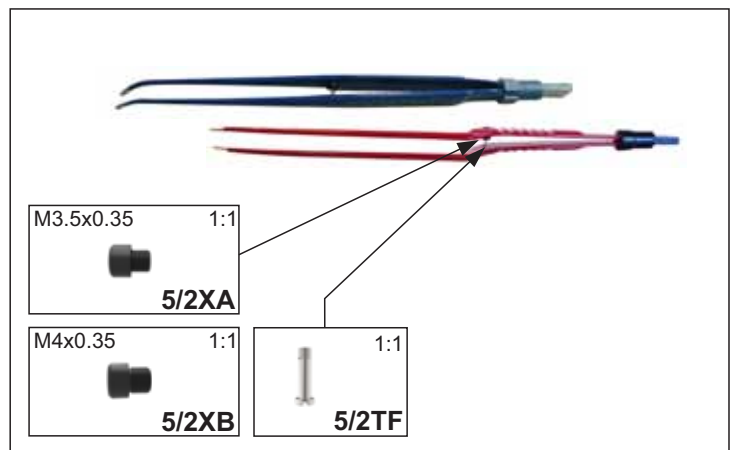
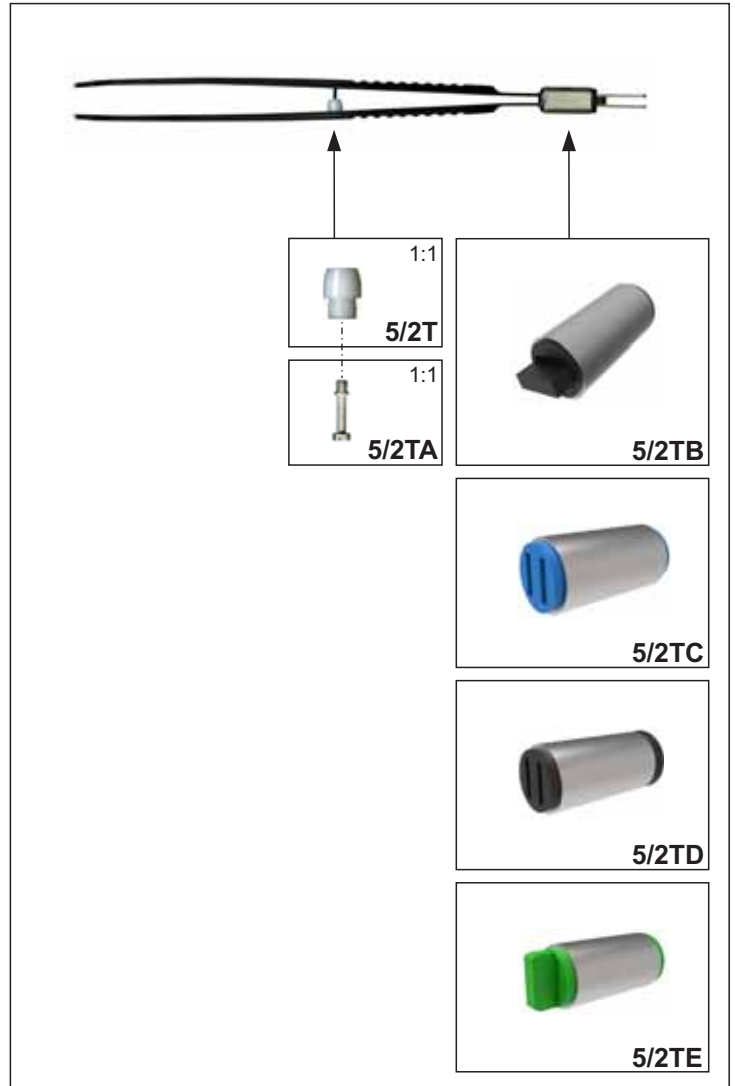
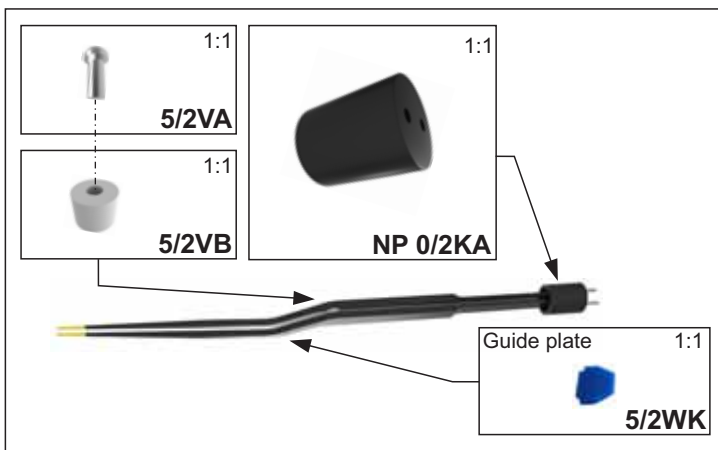
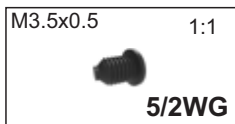
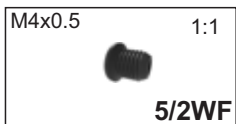
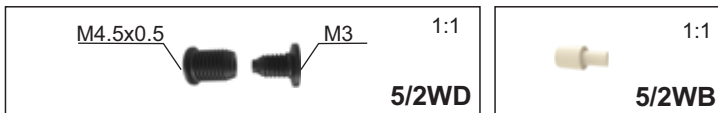
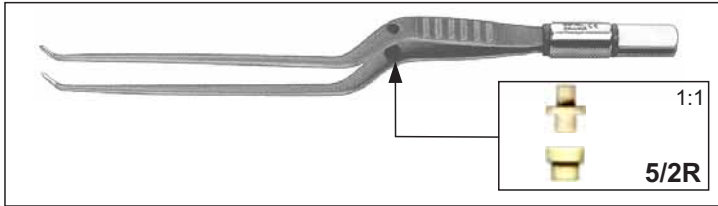
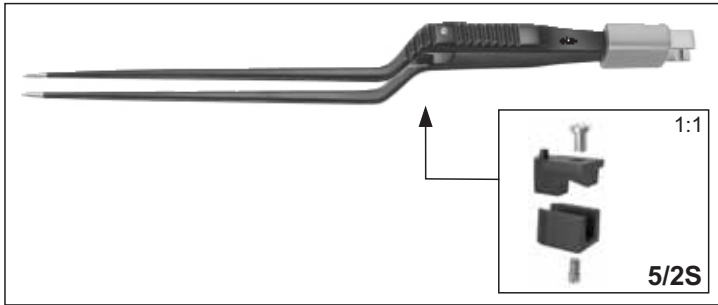

080617 5/2-3

Springs

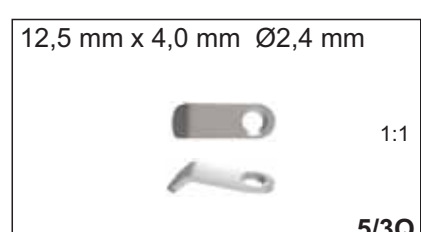
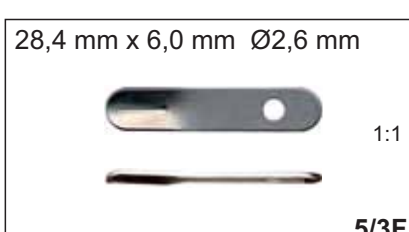
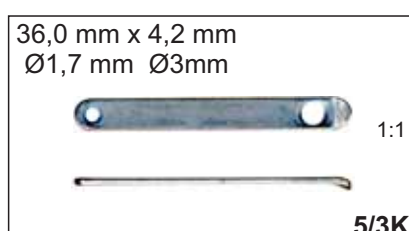
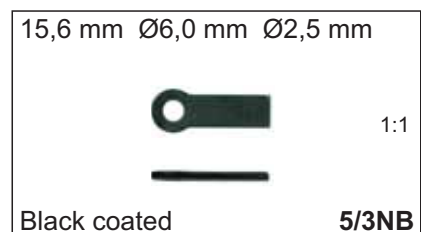
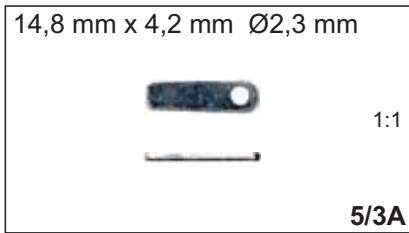
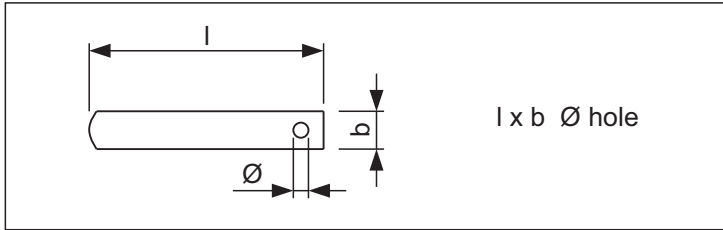

020817 5_3

Rollersprings (ask for other sizes)

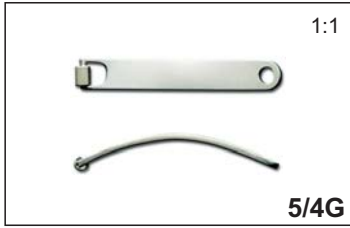

5/4A



5/4B



5/4C



5/4D



5/4E



5/4F

261107 5_04

Rollersprings (ask for other sizes)



1:1

5/5A



1:1

5/5B



1:1

5/5C



1:1

5/5D



1:1

5/5E



1:1

5/5F



1:1

5/5G



1:1

with pin

5/5H



261107 5_05

Springs

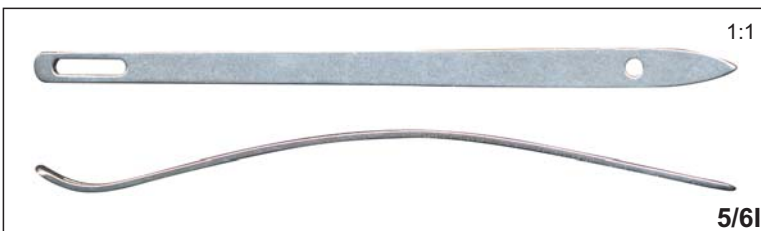
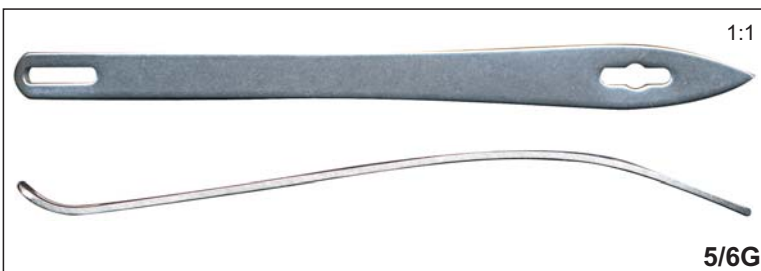
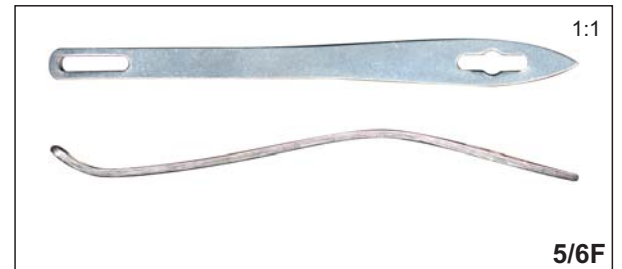
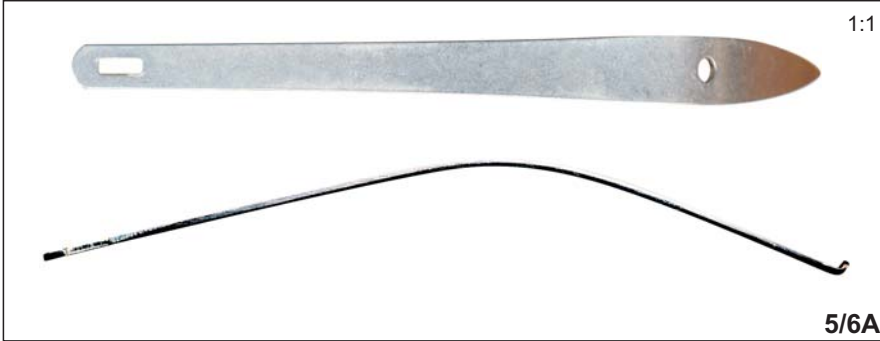

ask for other sizes!

Springs

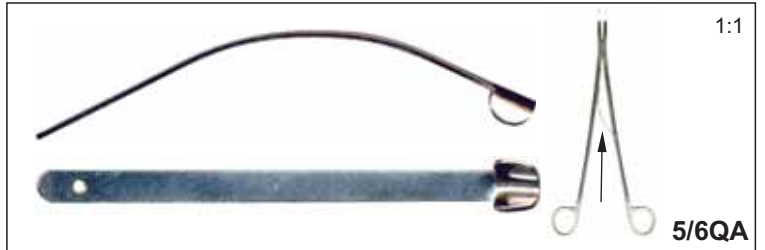
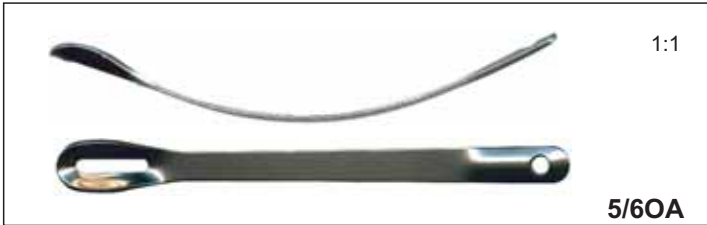

020817 5_6-2

Springs

ask for other sizes!

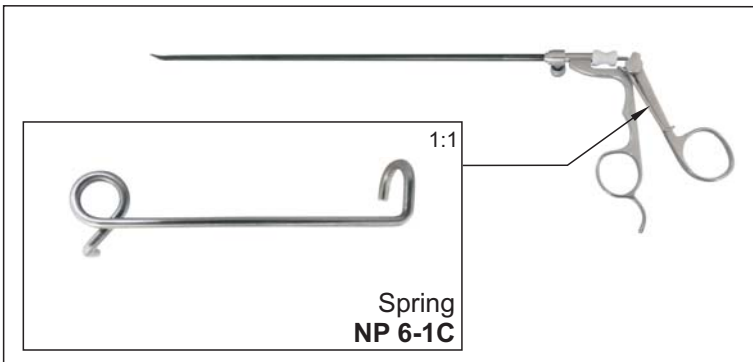
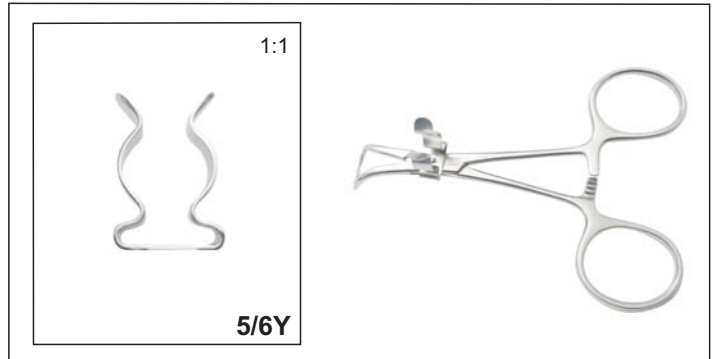
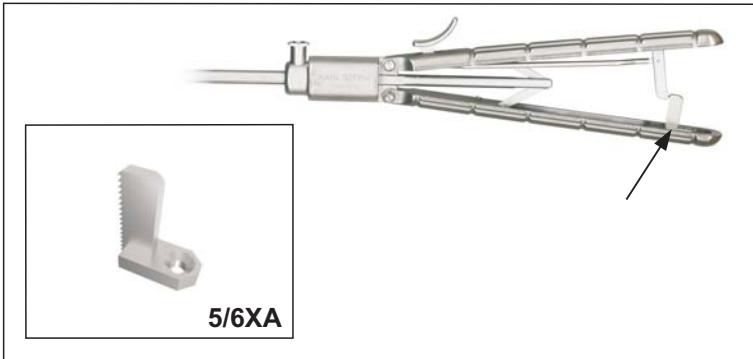
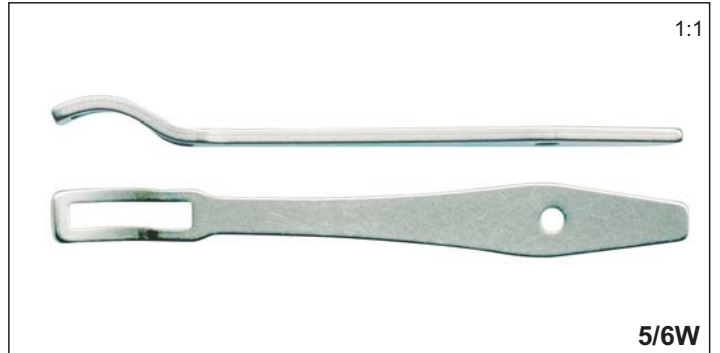
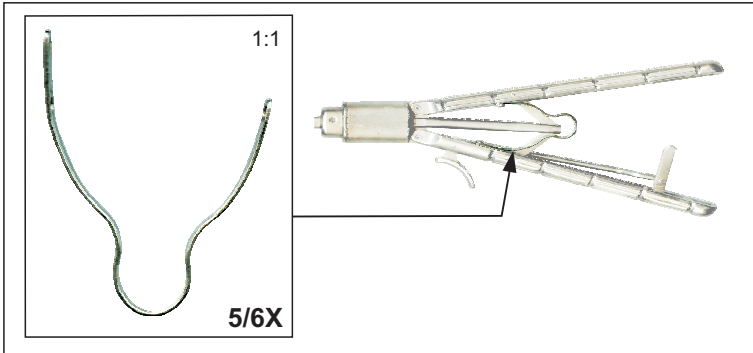

Special Springs

(ask for other sizes, we manufacture springs in accordance with your drawing and / or sample)

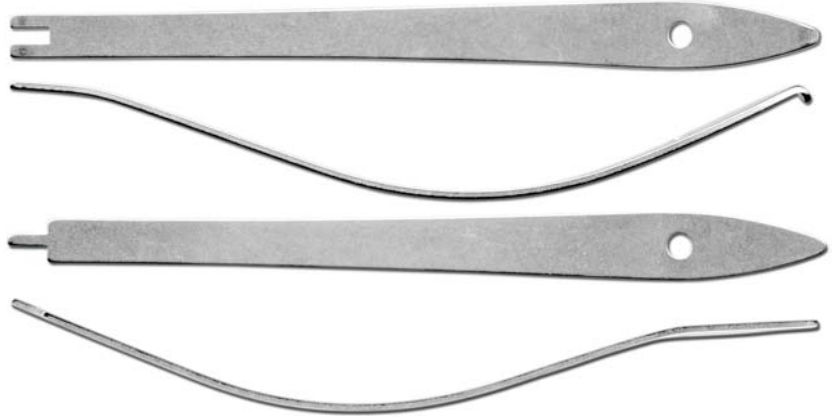

5/7A

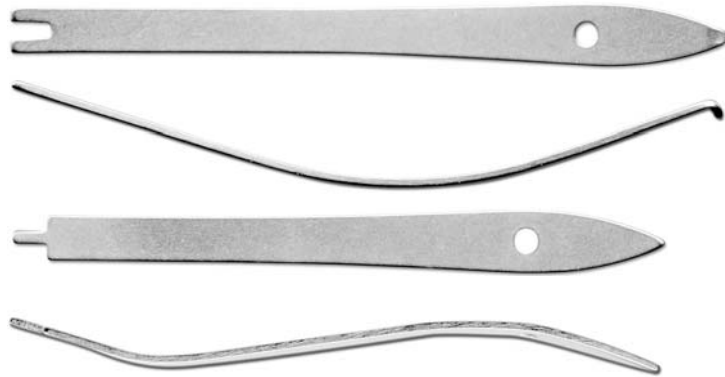

1:1

5/7B

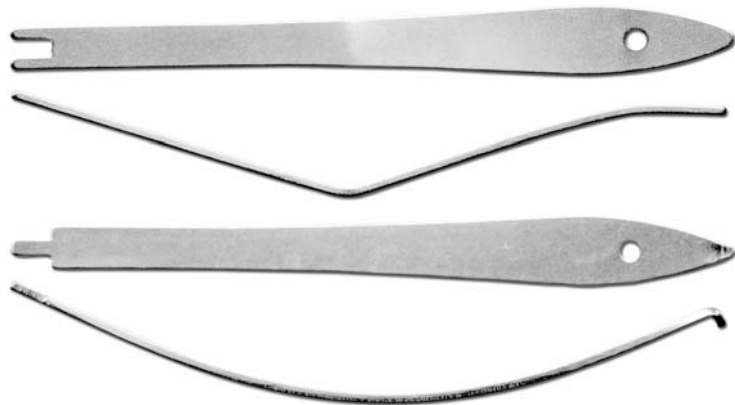

1:1

5/7BA

091109 5_07_1A-1

Special Springs

(ask for other sizes, we manufacture springs in accordance with your drawing and / or sample)

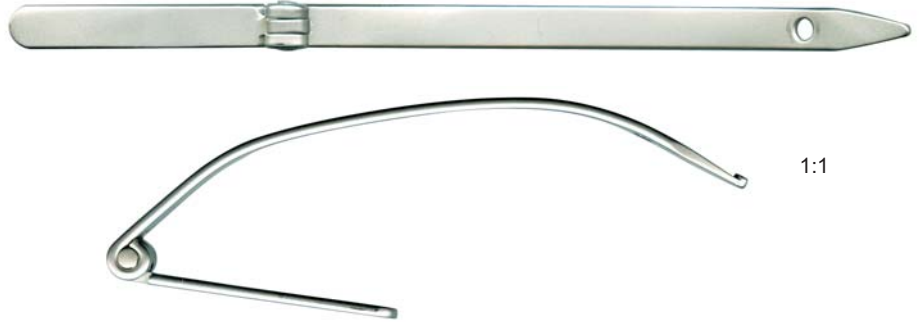

1:1

5/7BB

Spare Parts for AES FG824R

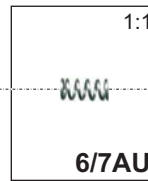
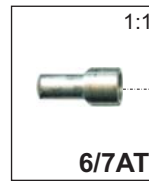
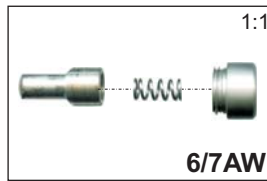

1:1

5/7BD

190411 5_07_1A-2

Special Springs

(ask for other sizes, we manufacture springs in accordance with your drawing and / or sample)

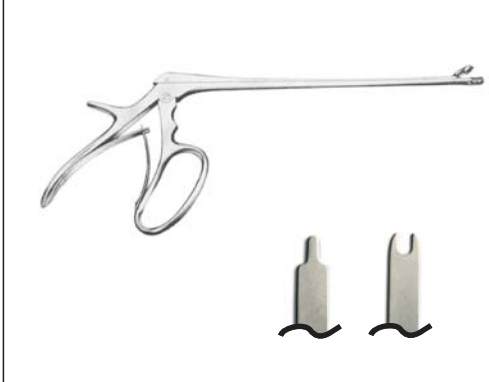
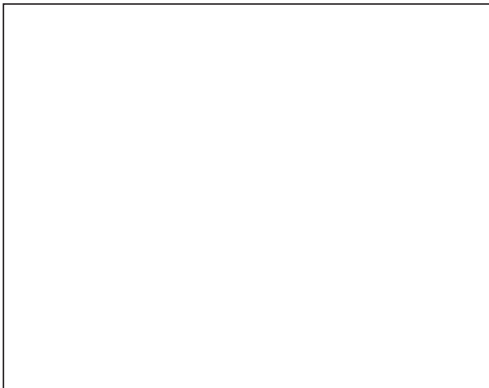
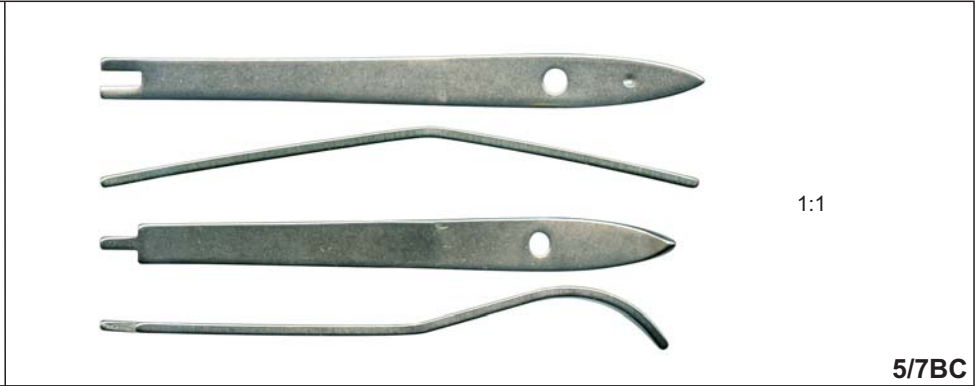

160616 5_07_1B

Special Springs

(ask for other sizes, we manufacture springs in accordance with your drawing and / or sample)

   <p>5/7D 5/7E</p>	 <p>1:1</p> <p>5/7D</p>
 <p>1:1</p> <p>5/7DA</p>	
 <p>1:1</p> <p>5/7DU</p>	
 <p>1:1</p> <p>5/7E</p>	
	 <p>1:1</p> <p>5/7 EB</p>

290909 5_07_1C

Special Springs

(ask for other sizes, we manufacture springs in accordance with your drawing and / or sample)



1:1

5/7EC



1:1

5/7ED



1:1



5/7F



5/7FB

290913 5_07_1D

Interlocking Springs (pair)

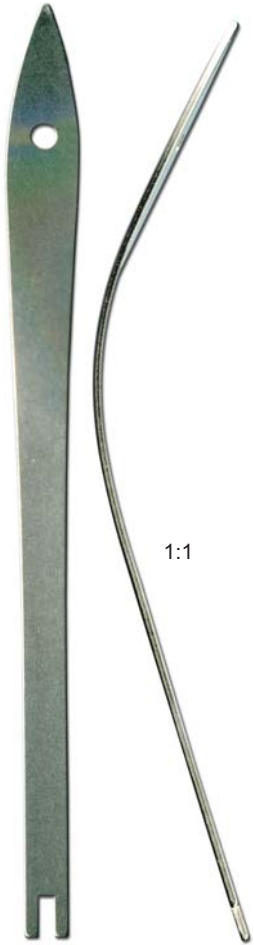

1:1

5/7G



1:1

5/7H

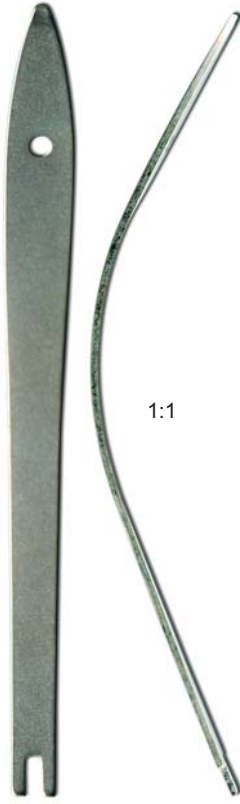

1:1

5/7I

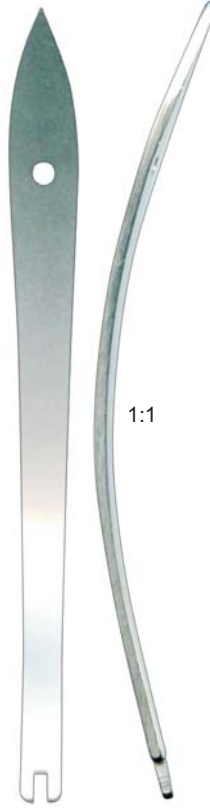

1:1

5/7IB



1:1

5/7J



1:1

5/7K



1:1

5/7L



1:1

5/7M



1:1

5/7MA



1:1

5/7N

5/7-2A

271211 5_07_2A

© 2016 copyright by **DANmed**

Interlocking Springs (pair)

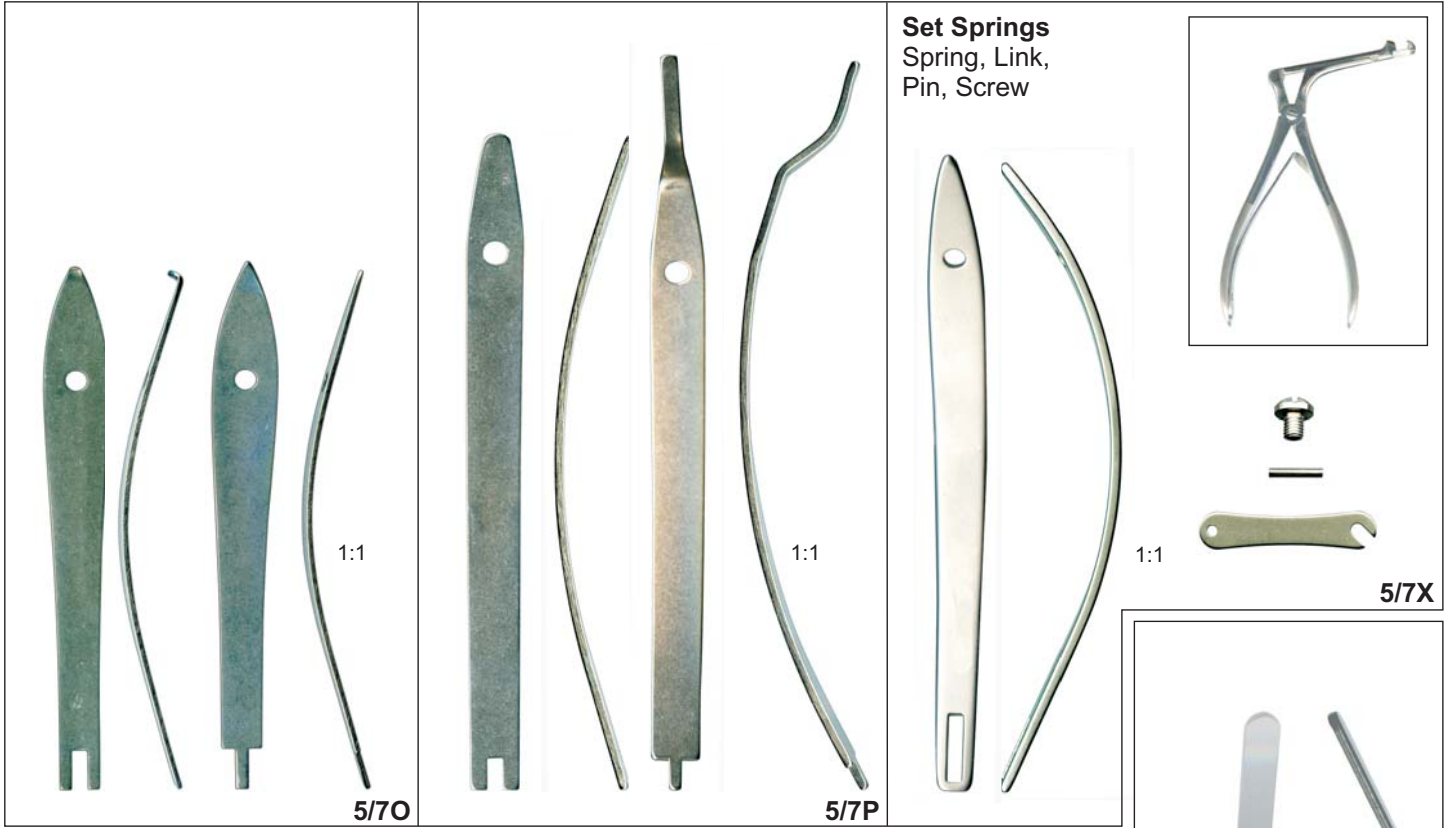

Diener-Style

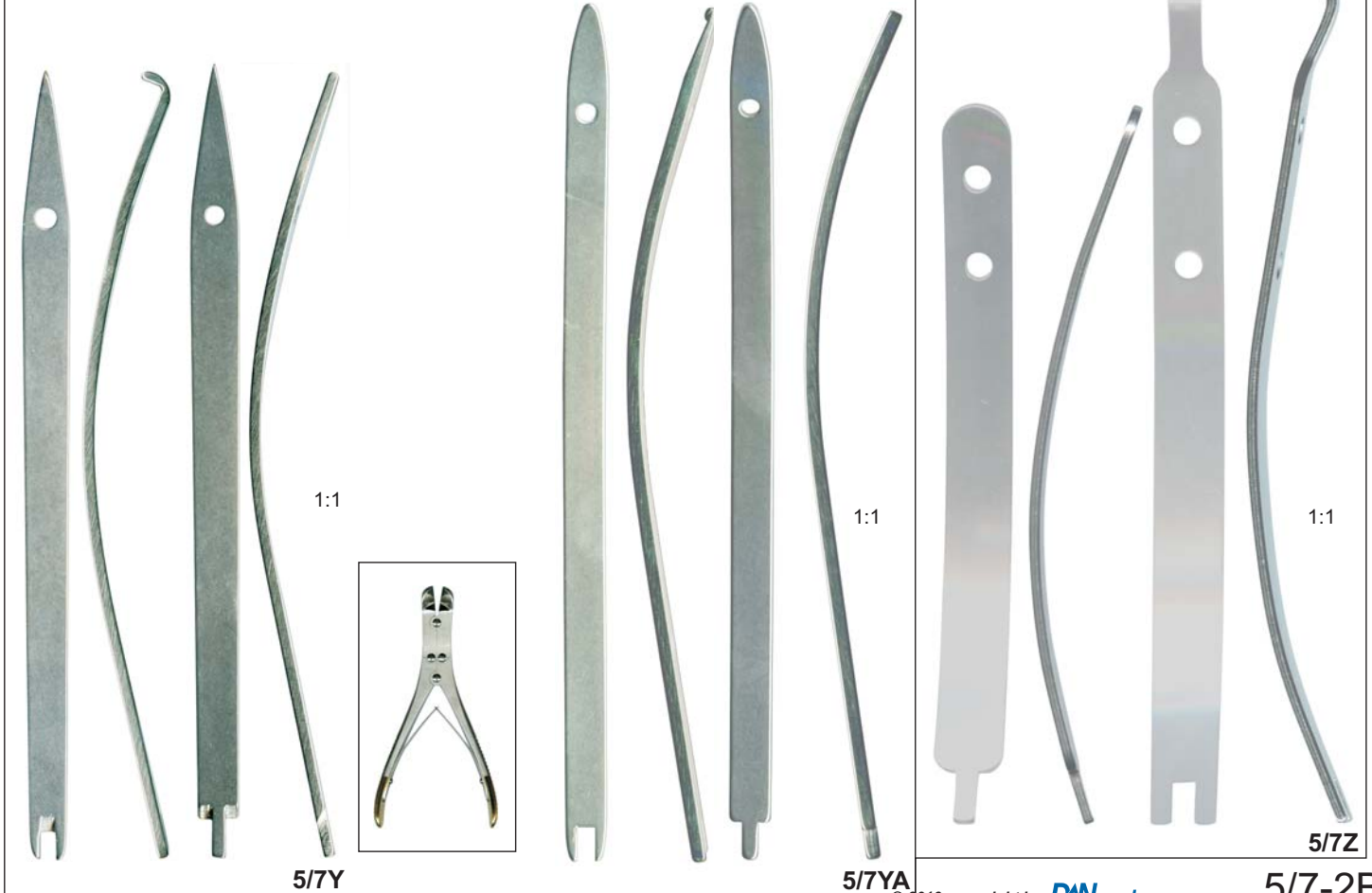

250809 5_07_2B

© 2016 copyright by DANmed

Interlocking Springs (pair)



5/7FB

1:1



5/7FG

1:1



5/7FH

1:1



5/7FHG

1:1



190116 5_07_2C

Ball & Cap Spring
(ask for other sizes)

black coated

black coated

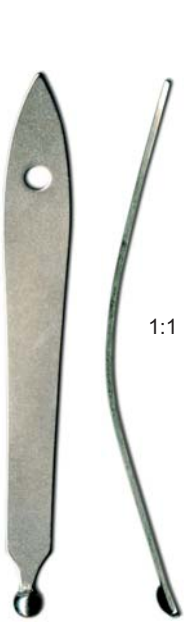

1:1

5/7Q

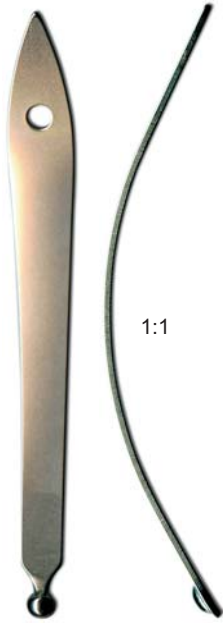

1:1

5/7R



1:1

5/7RA

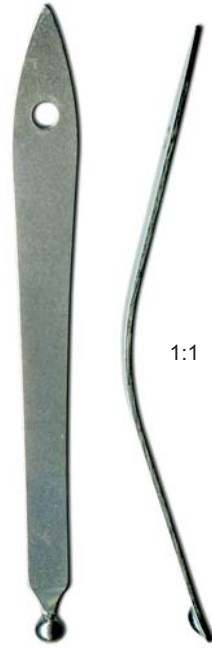

1:1

5/7S



1:1

5/7SA

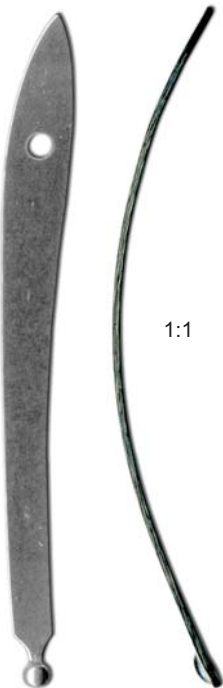

1:1

5/7T



1:1

5/7U



1:1

5/7V



1:1

5/7W

190710 5_07_3

© 2016 copyright by **DANmed**

5/7-3

Retractor gear & key

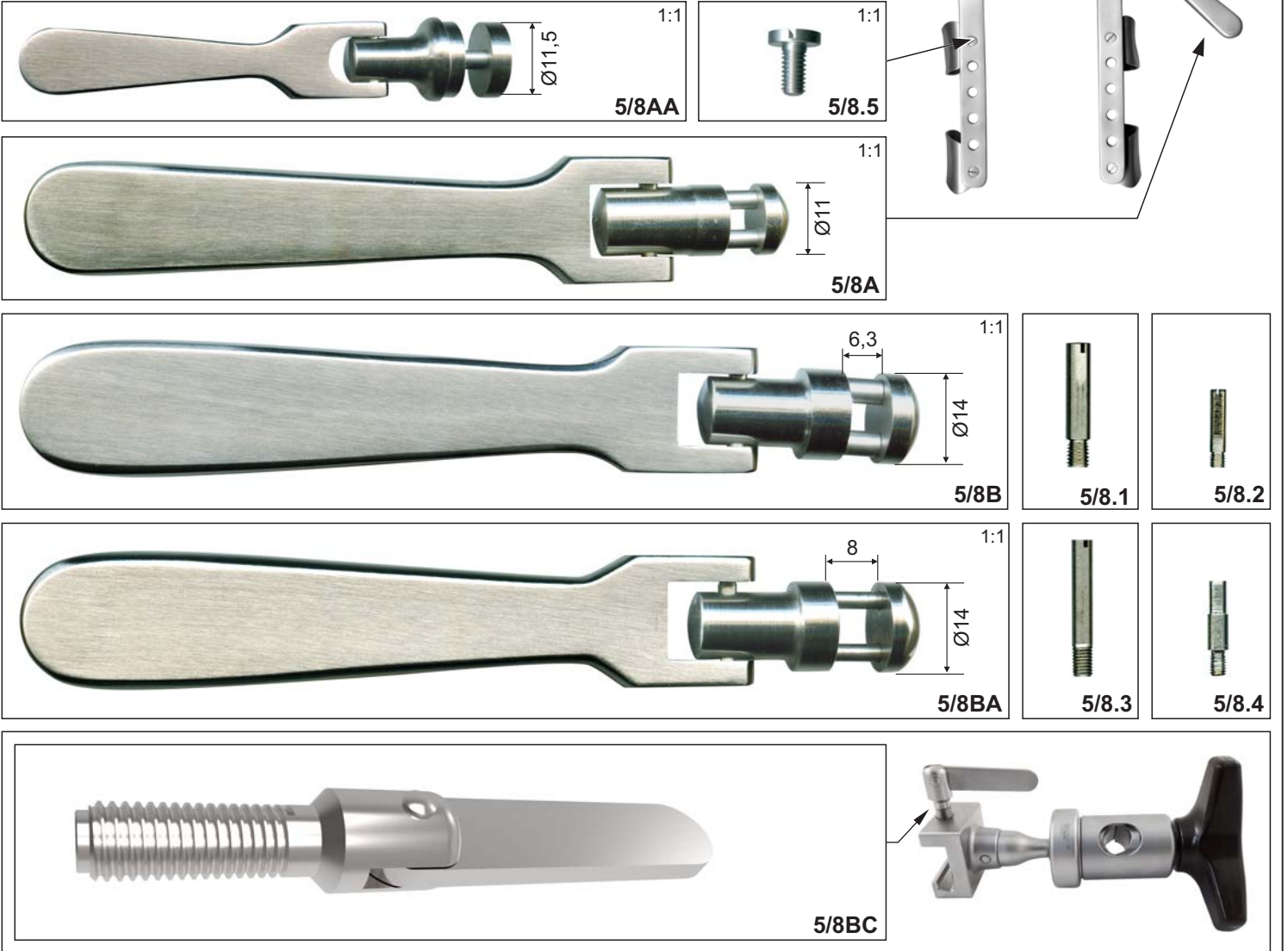

080317 5_08-1A-1

Retractor gear & key OMNI-Retractor small

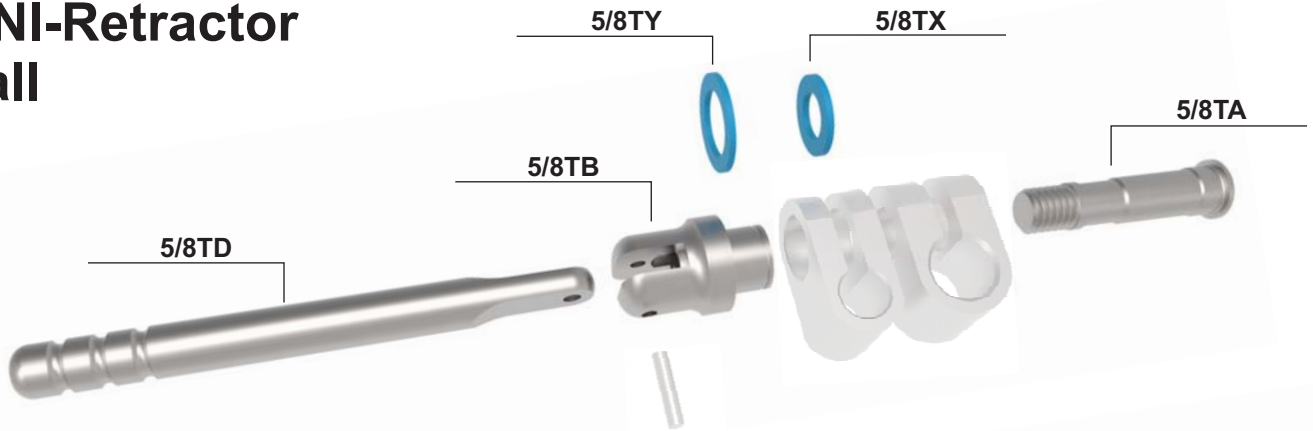

OMNI-Retractor big

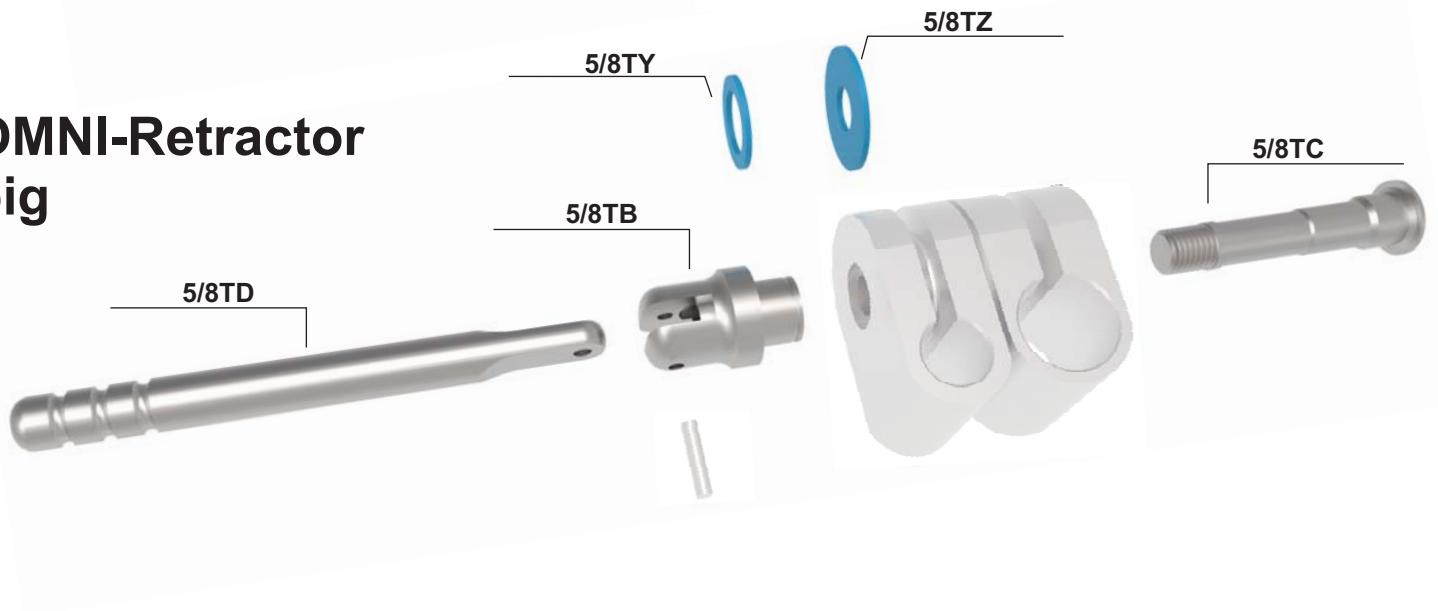

Retractor gear & key

<p>7 gears Ø6,5 mm 16 1:1 5/8C</p>	<p>8 gears Ø8 mm 16 1:1 5/8CA</p>	<p>1:1 5/8CS</p>	<p>8 gears Ø6,5 mm 16 1:1 5/8D</p>
<p>7 gears Ø6,5 mm 15,5 1:1 5/8DD</p>	<p>Usable for AES</p> <p>10 gears Ø6 mm 11 1:1 5/8FA</p> <p>1:1 5/8EA</p> <p>1:1 5/8KA</p> <p>1:1 5/8FB</p> <p>1:1 5/8K</p>		
<p>1:1 5/8JE</p>	<p>1:1 5/8L</p>		
<p>Usable for AES</p> <p>1:1 5/8LA</p>		<p>Usable for AES</p> <p>1:1 5/8LC</p>	
<p>8 gears Ø6 mm 15 1:1 5/8N</p>		<p>8 gears Ø6 mm 10 1:1 5/8O</p>	

101013 5_08-1B

Retractor gear & key

<p>7 gears Ø6,5 mm 16 1:1 5/8C</p>	<p>8 gears Ø8 mm 16 1:1 5/8CA</p>	<p>1:1 5/8CS</p>	<p>8 gears Ø6,5 mm 16 1:1 5/8D</p>
<p>7 gears Ø6,5 mm 15,5 1:1 5/8DD</p>	<p><i>Usable for AES</i></p> <p>10 gears Ø6 mm 11 1:1 5/8FA</p> <p>1:1 5/8EA</p> <p>1:1 5/8KA</p> <p>1:1 5/8FB</p> <p>1:1 5/8K</p>		
<p>8 gears Ø6 mm 15 1:1 5/8N</p>	<p>8 gears Ø6 mm 10 1:1 5/8O</p>		

300615 5_08-1B-1

Retractor gear & key

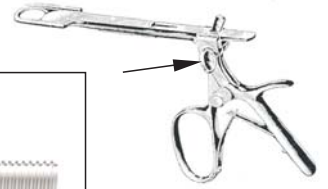
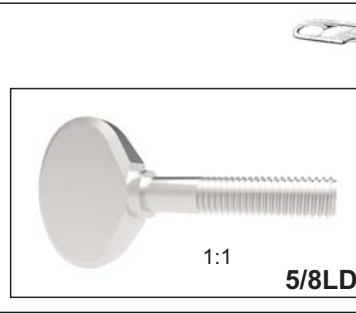
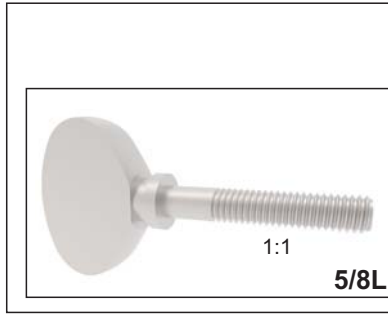
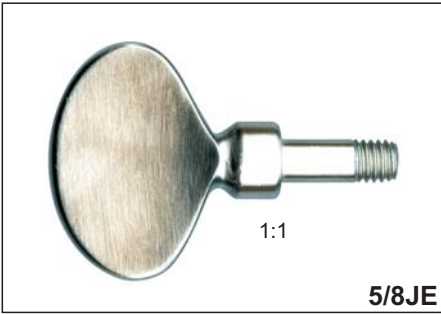

Usable for AES

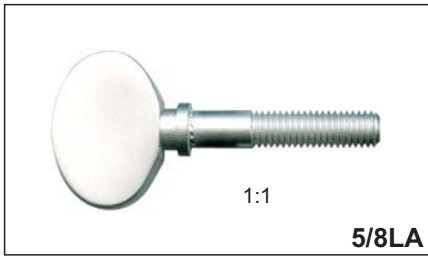

Usable for AES

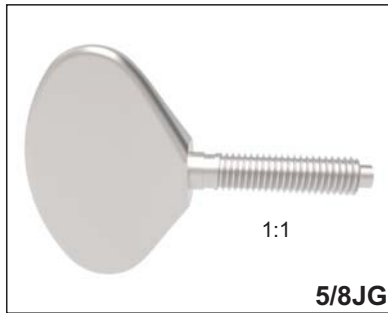
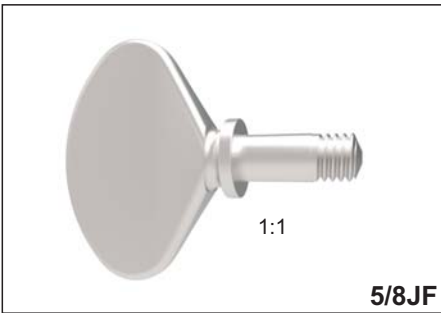
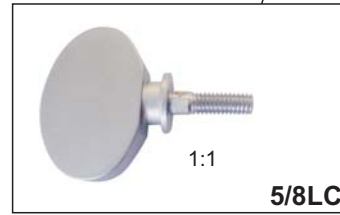

Spare Parts usable for Specula

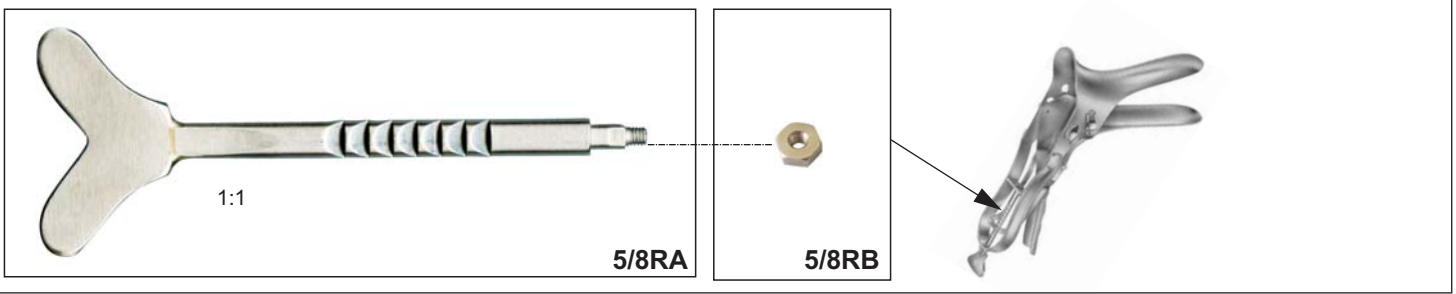
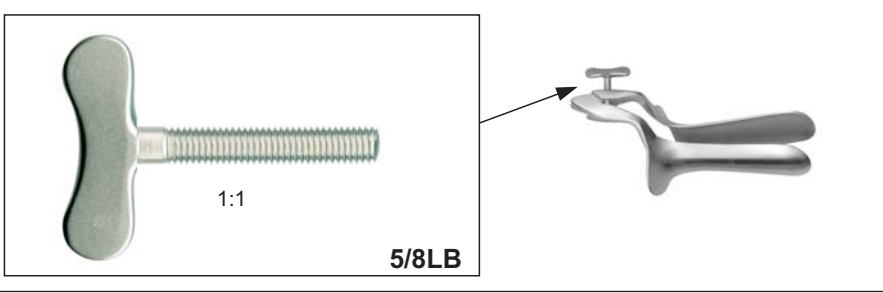

Wing Nut

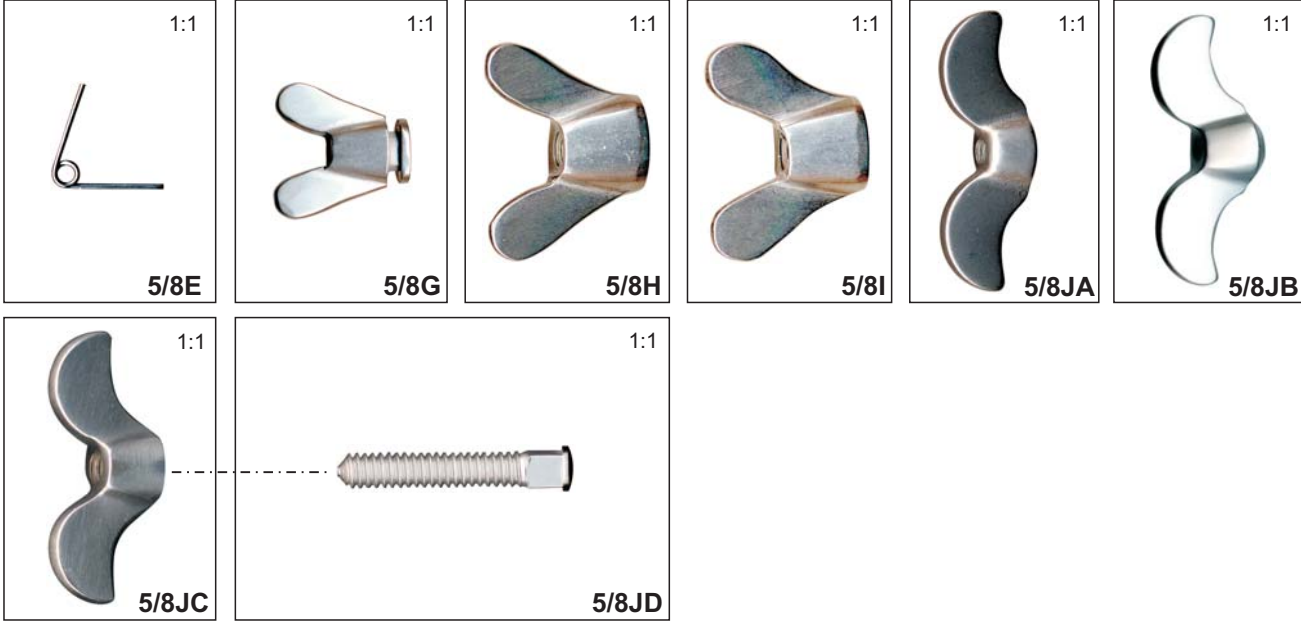

Retractors Self-Retraining

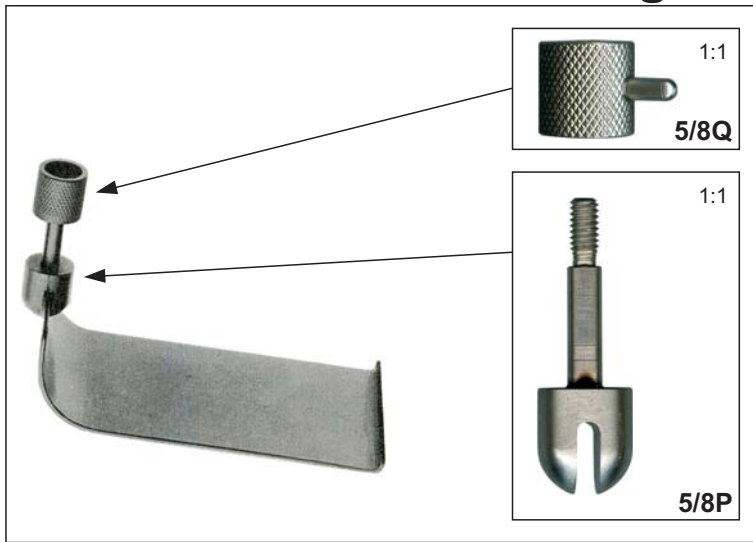

Pins for Tonsillotom Sluder-Ballenger

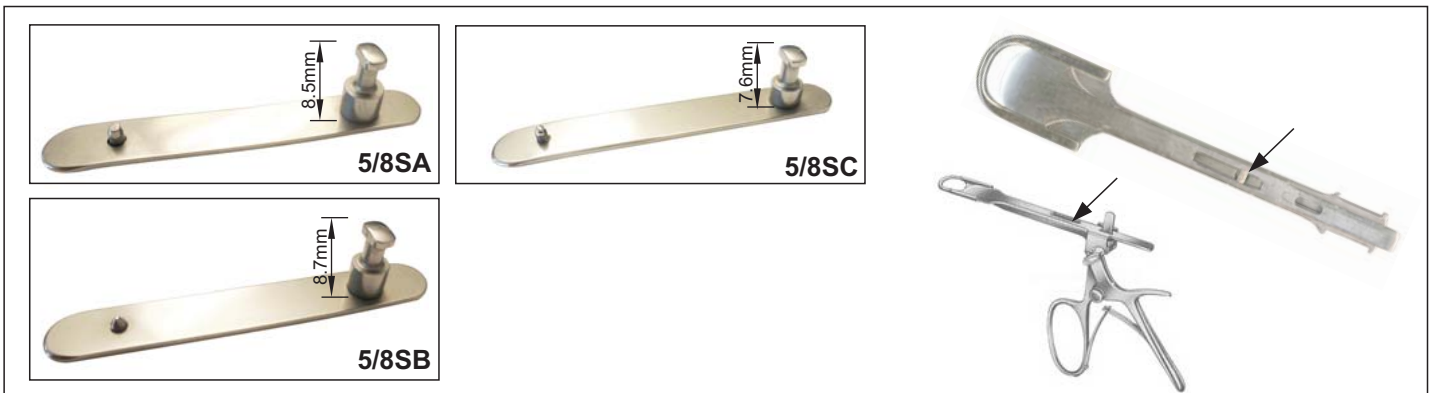

280714 5_08-2

Valves and stopcocks

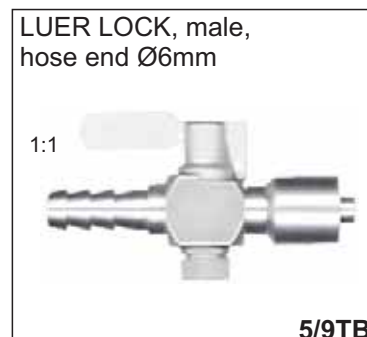
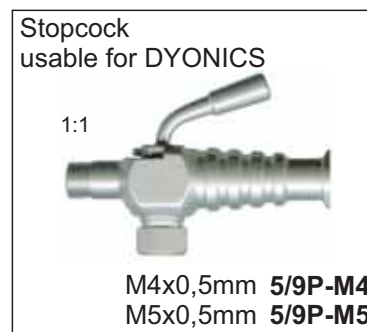
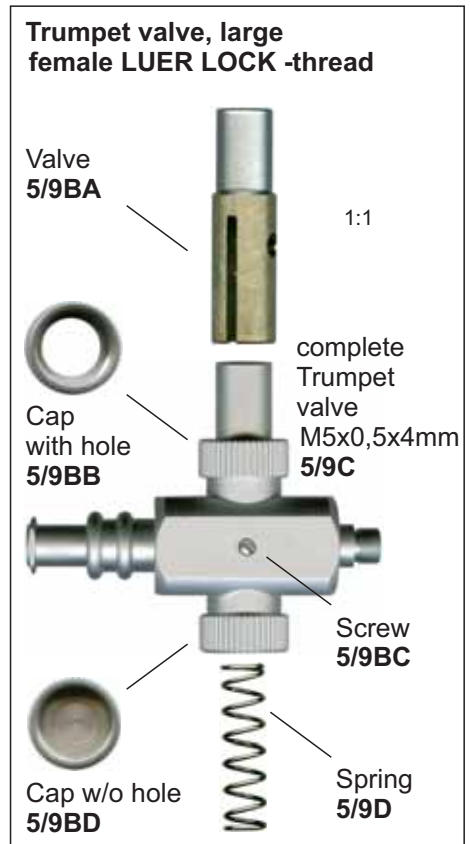
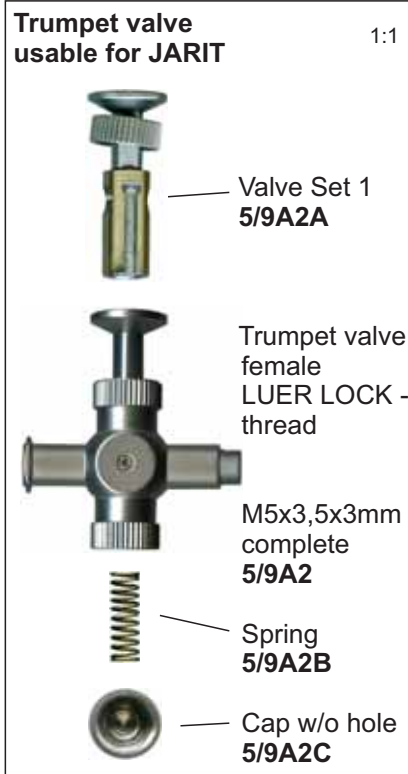
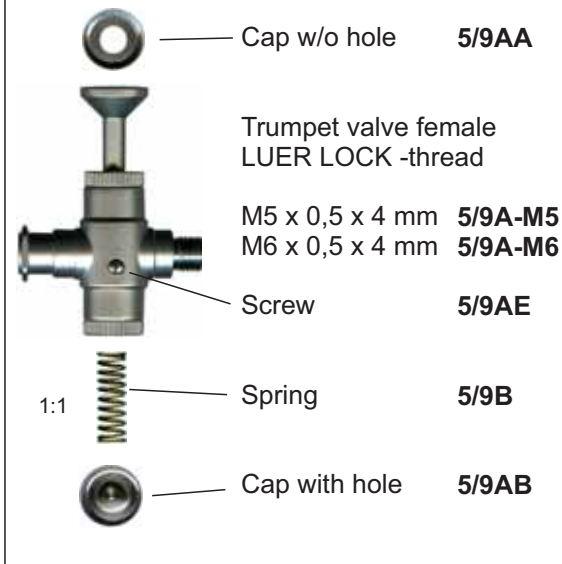

080617 5_09-1A

Valves and stopcocks

Stopcock, left with LLM



1:1

5/9YA

1:1



Stopcock left hand **5/9Y**
Stopcock right hand **5/9Z**

Plug male
LUER LOCK

1:1



5/9HA

Plug male
LUER LOCK

1:1



5/9HB

Plug female
LUER LOCK

1:1



5/9I

Pin for
Stopcock

1:1



5/9K

Pin for
Stopcock flat

1:1



5/9L

Spring for
Verres-needle

1:1



5/9N

Lever f.
Stopcock
Ø 5mm

1:1



5/9Q

Special grease
for Stopcocks



5/9ZA

Silicon oil, 20 ml



5/9ZB

Plug female
small Ø2.7mm
LUER LOCK

1:1



5/9ZC

Adapter LLW

1:1



M4,0 x 0,5mm **5/9V**
M4,5 x 0,5mm **5/9W**
M5,0 x 0,5mm **5/9X**

Replacement parts for trocar sleeves

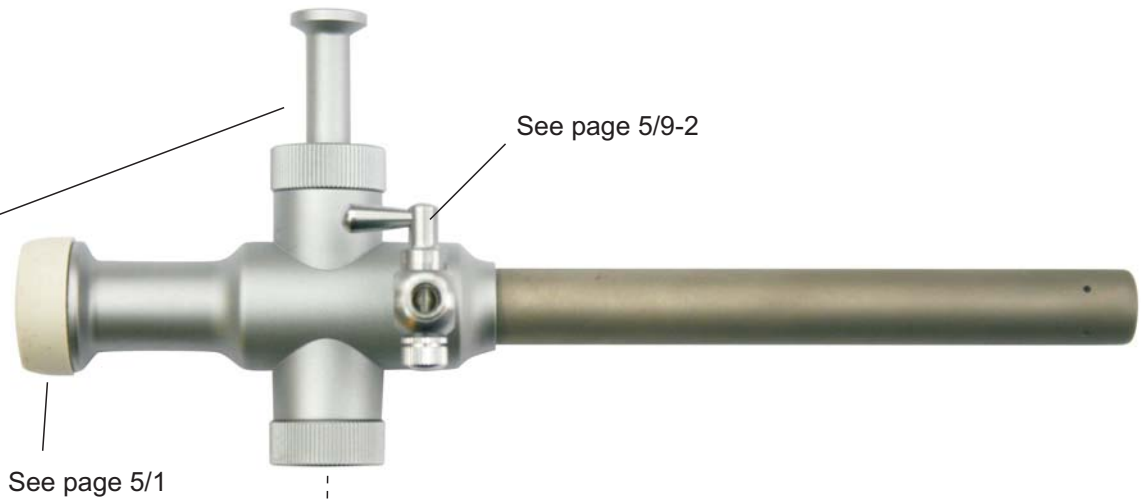

Spring Ø7 x 26 mm
5/9-1A01



Cap, thread 12 x 0,5 mm
5/9-1A02

Cap, thread 16 x 0,75 mm
5/9-1A03

Protector Caps

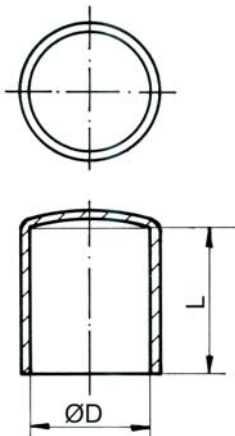

Protector Cap
Ø12 mm / L= 35 mm



5/9-1A10

Protector Cap
Ø5,5 mm / L= 30 mm



5/9-1A11

Protector Cap
Ø1,5 mm / L= 20 mm



5/9-1A12

Protector Cap
Ø3 mm / L= 20mm



5/9-1A13

030512 5_09-1C

Replacement parts for suction and irrigation handle

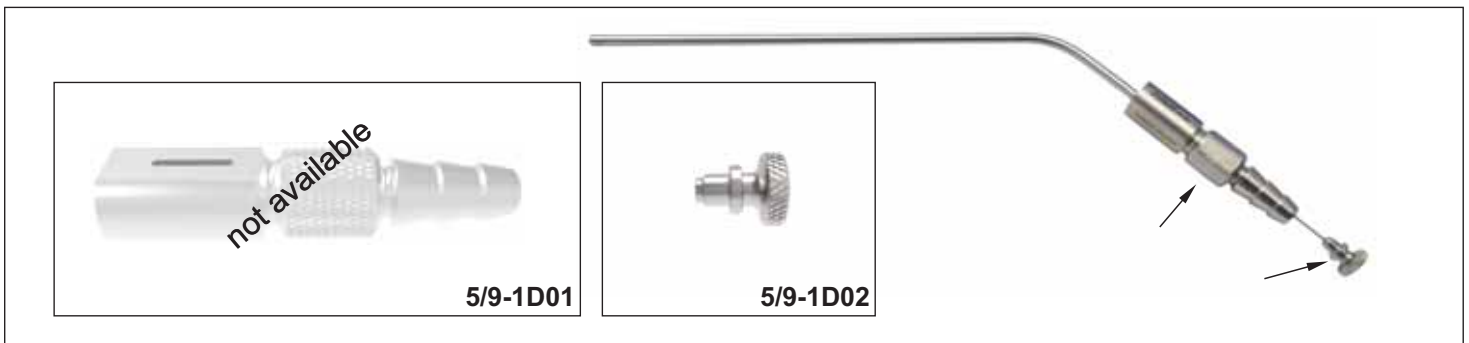
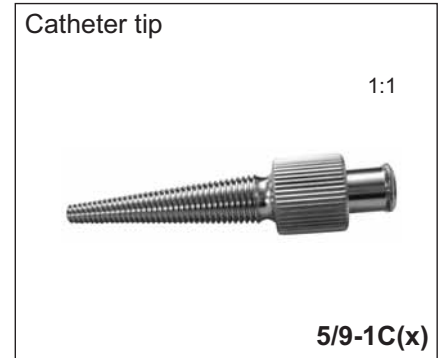
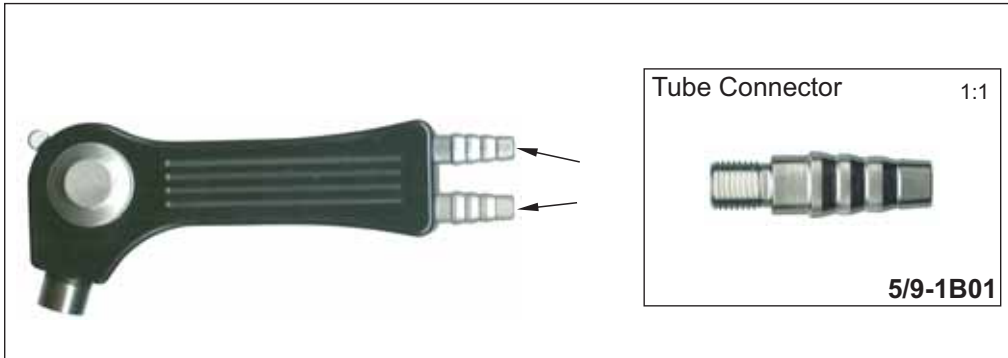

Piston for Stopcock

<p>Piston #1</p>  <p>1:1</p> <p>5/9 P01</p>	<p>Piston #2</p>  <p>1:1</p> <p>5/9 P02</p>	<p>Piston #3 (left)</p>  <p>1:1</p> <p>right site - please look piston #7</p> <p>5/9 P03</p>	<p>Piston #4</p>  <p>1:1</p> <p>5/9 P04</p>
<p>Piston #5</p>  <p>1:1</p> <p>5/9 P05</p>	<p>Piston #6</p>  <p>1:1</p> <p>5/9 P06</p>	<p>Piston #7 (right)</p>  <p>1:1</p> <p>left site - please look piston #3</p> <p>5/9 P07</p>	<p>Piston #8</p>  <p>1:1</p> <p>5/9 P08</p>
<p>Piston #9</p>  <p>1:1</p> <p>5/9 P09</p>	<p>Piston #10</p>  <p>1:1</p> <p>5/9 P10</p>	<p>Piston #11</p>  <p>1:1</p> <p>5/9 P11</p>	<p>Piston #12</p>  <p>1:1</p> <p>5/9 P12</p>
<p>Piston #13</p>  <p>1:1</p> <p>5/9 P13</p>	<p>Piston #14 usable for ACMI</p>  <p>1:1</p> <p>5/9 P14</p>	<p>Piston #15 usable for WO</p>  <p>1:1</p> <p>5/9 P15</p>	<p>Piston #16 usable for DYONICS</p>  <p>1:1</p> <p>5/9 P16</p>
<p>Piston #18 Stainless Steel</p>  <p>1:1</p> <p>5/9 P18</p>	<p>Spring for Cap #14 usable for ACMI</p>  <p>1:1</p> <p>5/9 F14</p>	<p>Cap #15 usable for WO</p>  <p>1:1</p> <p>5/9 C15</p>	<p>Cap #16 usable for DYONICS</p>  <p>1:1</p> <p>5/9 C16</p>
<p>Cap #14 usable for ST and for ACMI</p>  <p>1:1</p> <p>5/9 C14</p>	<p>Cap #17 usable for ST</p>  <p>1:1</p> <p>5/9 C17</p>	<p>Cap #20 usable for ST and for ACMI STAINLESS STEEL</p>  <p>1:1</p> <p>5/9 C20</p>	

310114_5_09-2A

Piston for Stopcock

Usable for WO

Piston #20
for Stopcock, left

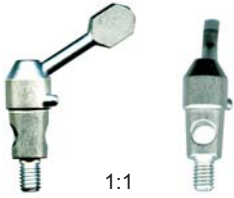

1:1

5/9 P20

Spring
for Stopcock



5/9 F30

Cap
for Stopcock



5/9 C15

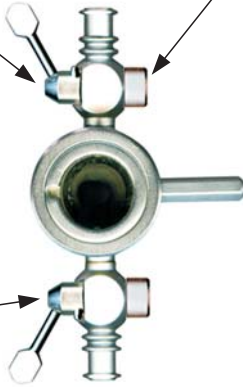

Usable for ST

Piston #26
for trocar 30103H2



1:1

5/9 P26

Piston #21
for Stopcock, right

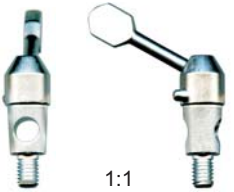

1:1

5/9 P21

Usable for STRYKER

Piston #22
for Stopcock, left / right

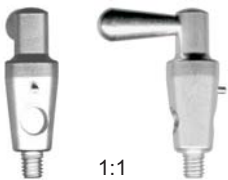

1:1

usable for STRYKER

5/9 P22

Piston #23
for Stopcock, left / right



1:1

usable for STRYKER

5/9 P23



Usable for OLY

Piston #24
for Stopcock, left



usable for OLY

5/9 P24

Piston #25
for Stopcock, right



usable for OLY

5/9 P25

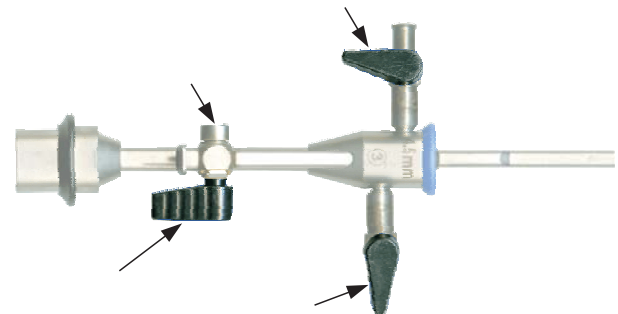

usable for OLY

5/9 C19

140711 5_09-2B

Piston for Stopcock

Usable for DYONICS

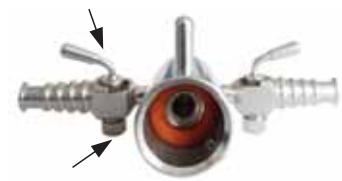
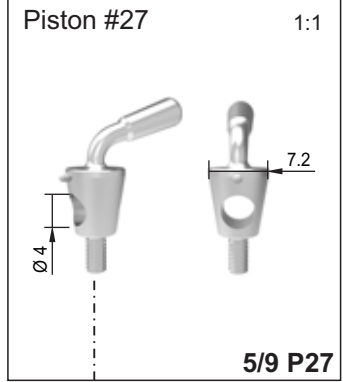
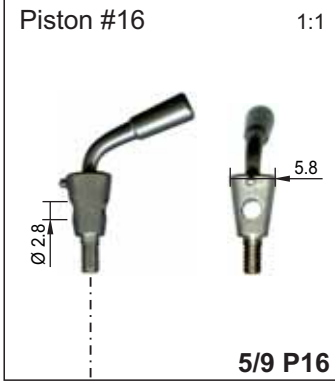

Yankauer parts



<p>YANKAUER Suction Tip #1</p>  <p>1:1</p> <p>M6 x 0,75 mm 5/9-3A01</p>	<p>YANKAUER Suction Tip #2</p>  <p>1:1</p> <p>M6 x 0,75 mm 5/9-3A02</p>	<p>YANKAUER Suction Tip #3</p>  <p>1:1</p> <p>M6 x 0,75 mm 5/9-3A03</p>	<p>YANKAUER Suction Tip #4 (chrom)</p>  <p>1:1</p> <p>brass M6 x 0,75 mm 5/9-3A04</p>
<p>YANKAUER Suction Tip #5</p>  <p>1:1</p> <p>Thread ¼" 5/9-3A05</p>	<p>YANKAUER Suction Tip #6</p>  <p>1:1</p> <p>M6 x 0,75 mm 5/9-3A06</p>	<p>YANKAUER Suction Tip #7</p>  <p>1:1</p> <p>¼ x 28" UNF 5/9-3A07</p>	<p>YANKAUER Suction Tip #8</p>  <p>1:1</p> <p>¼ x 32" UNF 5/9-3A08</p>
<p>YANKAUER Olive</p>  <p>1:1</p> <p>ID Ø 4 mm 5/9-3B01</p>	<p>YANKAUER Olive (chrom)</p>  <p>1:1</p> <p>ID Ø 3 mm 5/9-3B02</p>	<p>YANKAUER Olive</p>  <p>1:1</p> <p>ID Ø 3,5 mm 5/9-3B03</p>	

Hollow handles - Stainless steel



5/10A



5/10B

not available



5/10C



5/10D



5/10E



5/10F



5/10G



5/10H



5/10I

not available



5/10J



5/10K



5/10L



5/10M



5/10XB



5/10MB



5/10XB



5/10N



5/10O



5/10P



5/10XB

1:1

060317 5_10A

Hollow handles - Stainless steel



5/10Q



5/10R



5/10S



5/10U



5/10V

Spare bulbs

Ophthalmoscope

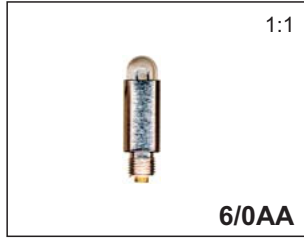
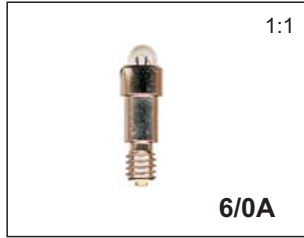

Otoscope

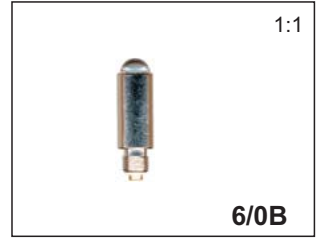
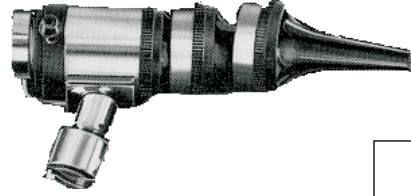

Head light

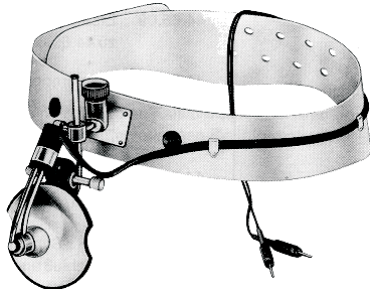

Laryngoscope



2-Component adhesives

UHU® plus system

UHU® plus schnellfest (color code: blue)

Working life 3 to 5 min. depending on temp. and quantity.
Hardening conditions 30 min. (25 °C) to 5 min (120 °C).

Direction for use:

surface must be cleaned very thoroughly, best when easily sanded. Mix components 1:1 parts. Only one surface to be glued. No pressure necessary.



Tensile strength:

10 min.	150 N/cm ²	$10 \text{ N/cm}^2 = 1 \text{ kg/cm}^2$
60 min.	1100 N/cm ²	
24 hours	1650 N/cm ²	

order no.: DAN-1008

UHU® plus endfest 300 (color code: green)

Working life 1.5 to 2 hr. depending on temp. and quantity.
Hardening conditions 12 hr. (20 °C) to 5 min (180 °C).

Direction for use:

surface must be cleaned very thoroughly, best when easily sanded. Mix components 1:1 parts. Only one surface to be glued. No pressure necessary.



Tensile strength:

20 °C	12 hr.	1200 N/cm ²	$10 \text{ N/cm}^2 = 1 \text{ kg/cm}^2$
100 °C	10 min.	2500 N/cm ²	
180 °C	5 min.	3000 N/cm ²	

order no.: DAN-1009

UHU® PLUS EPOXY Quick Set adhesive, Double syringe 27g

- Transparent 2-component-adhesive based on epoxy resin for fast and strong bonding
- Working time: approx. 5 min
- Initial strength: after approx. 20 min
- Final bond strength: approx. 1900 N/cm²
- Impact, ageing and moisture resistant



order no.: DAN-1008B

Solder accessories



Liquid flux water for soft solder wire (8.82 oz.)

Soldering flux and soft plumb line to soldering of stainless steel.

order no.: 6/1A



Soft plumb line (8.82 oz.)

order no.: 6/1B



Flux paste for brazing of heavy metals(3.53 oz.)

Flux paste and silver plumb line for brazing of heavy metals.

order no.: 6/1C



Silver plumb line

order no.: 6/1D

Work Shop Equipment



TAP for vice
6/2A



1:1

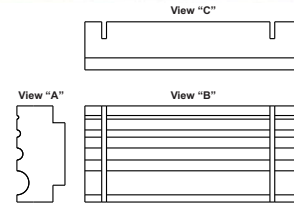

Vice block
6/2D



Ground Thread
Machine Taps
6/2B



Round Solid Dies
6/2C



1:2

French Catheter Scale
6/2L



pliers with
copper- insert

1:1

Copper pliers
6/2E



Reamer - set
6/2R-SET A

130312 6_2A

Work Shop Equipment

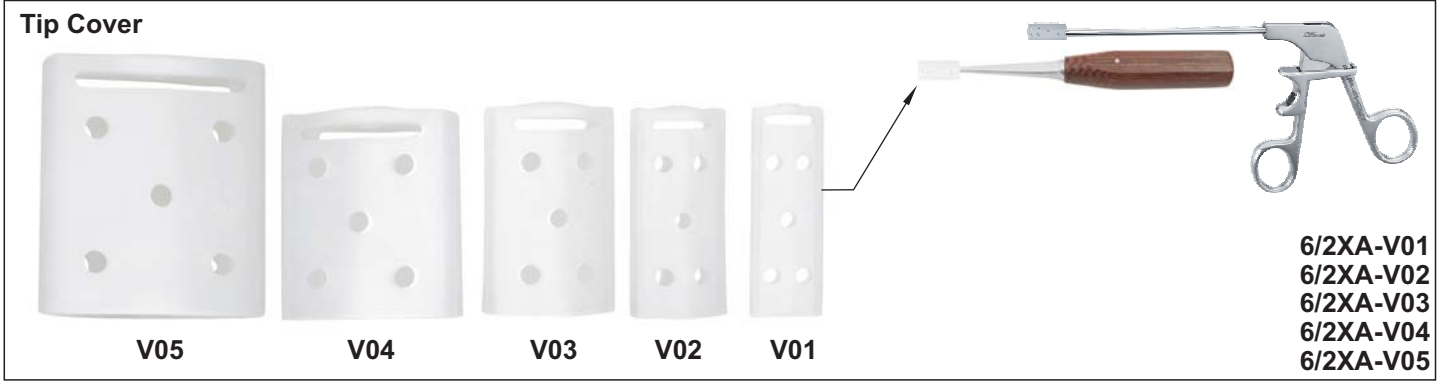
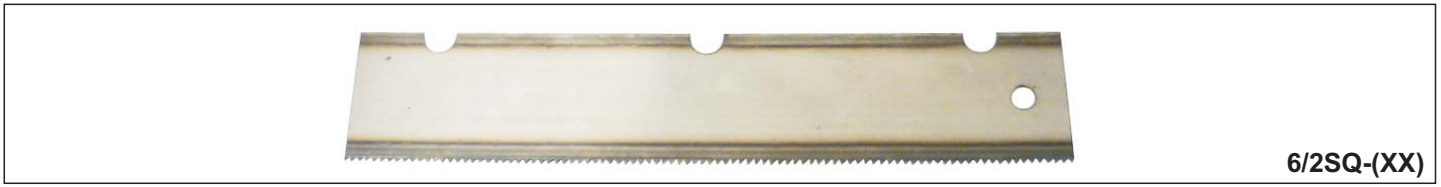
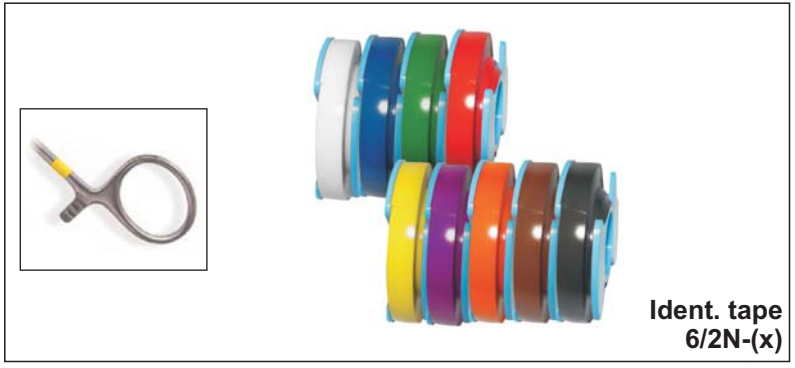

051115 6_2B

Work Shop Equipment

Oil Pen



6/2QB



6/2QB-SET



5 liter **6/2QBA**
20 liter **6/2QBB**

Test-equipment refill packs



6/2QC



6/2QG



6/2QD



6/2QH



6/2QE



6/2QI



6/2QF



NP 1/9C

Test-equipment according to DIN 58298



To test the functional capability of medical instruments. The test-equipment includes test material for the following medical instruments:

- bone cutting forceps and rongeurs, bone punches
- cutting conchotomes
- scalpels and knives
- non-cutting conchotomes
- surgical scissors
- forceps
- needle holders
- atraumata forceps
- chisels, raspatories, bone curettes and gouges

6/2QA







160915 6_2C

Work Shop Equipment

**SET of Buff files, escapement files,
6 pcs. in a box for bevelling**



Set includes following files:

	halfround	4.0x1.3mm
	crossing	3.7x1.4mm
	barrette	3.9x1.2mm
	3-square	2.8mm
	pillar	3.6x0.8mm
	round	Ø1.5mm



brushes with stainless steel bristles



brushes with brass bristles



brushes with nylon bristles (autoclavable)



brushes with double sided nylon bristles (autoclavable)

brush with nylon bristles



brush with brass bristles



brush with nylon bristles and cleaning rubber



6/2Y-SET

Electrodes for Resectoskopes - doublestem

The Cutting loops will be supplied with standard wire diameter of 0.35 mm



Cutting loop, angeled
6/3A



Cutting loop, 90°
6/3B



Cutting loop, straight in longitudinal direction
6/3C



Coagulations-electrode pointed
6/3D



Coagulations-electrode ball shape Ø 3 mm
6/3E



Coagulations-electrode conical
6/3F

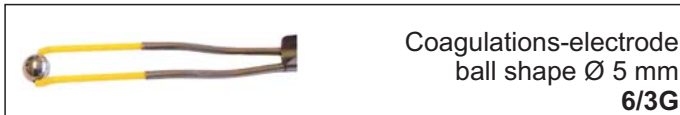

Coagulations-electrode ball shape Ø 5 mm
6/3G



Coagulations-electrode roller shape Ø 3 mm
6/3H



Coagulations-electrode roller shape Ø 5 mm
6/3I



Spike-electrode Ø 3 mm
6/3J



Spike-electrode Ø 5 mm
6/3K



Roller-electrode Ø 3 mm
6/3L



Roller-electrode Ø 5 mm
6/3M



Vapor-electrode band width 1,2 mm
6/3N



Vapor-electrode band width 0,6 mm
6/3O

Knife



Knife, even
6/3W



Serrated knife
6/3X



Knife, roundly
6/3Y



Knife, hooked
6/3Z

Electrodes for Resectoskopes

The Cutting loops will be supplied with standard wire diameter of 0.35 mm



Cutting loop, angled
6/4A



Cutting loop, 90°
6/4B



Cutting loop, straight in longitudinal direction
6/4C



Coagulations-electrode pointed
6/4D



Coagulations-electrode ball shape Ø 3 mm
6/4E



Coagulations-electrode conical
6/4F

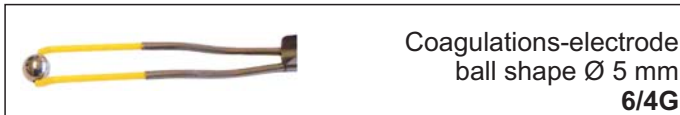

Coagulations-electrode ball shape Ø 5 mm
6/4G



Coagulations-electrode roller shape Ø 3 mm
6/4H



Coagulations-electrode roller shape Ø 5 mm
6/4I



Spike-electrode Ø 3 mm
6/4J



Spike-electrode Ø 5 mm
6/4K



Roller-electrode Ø 3 mm
6/4L



Roller-electrode Ø 5 mm
6/4M



Vapor-electrode band width 1,2 mm
6/4N



Vapor-electrode band width 0,6 mm
6/3O

Handle

We manufacture handles in accordance with your drawing and / or sample



6/5A



6/5B



6/5 C,C-(x),C0



6/5D

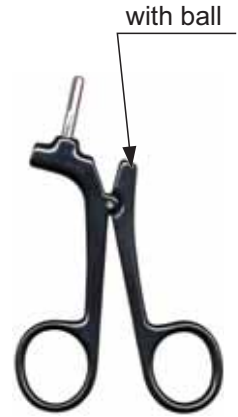

6/5E



6/5F



6/5F-VIT



6/5G



6/5H



6/5I



6/5J



6/5K



6/5L



6/5M

















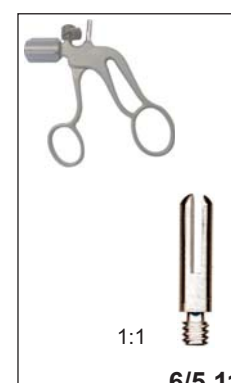

6/5TA for Ø 3.5mm
6/5TB for Ø 2.0mm

030817 6_5A

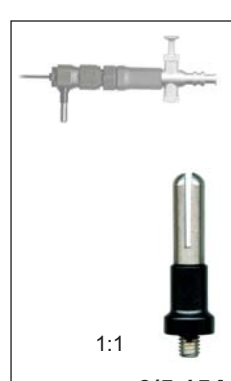
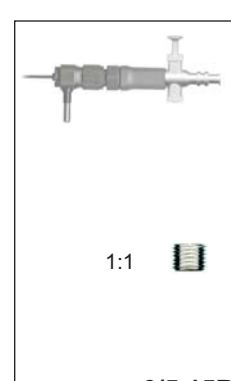
Handle post

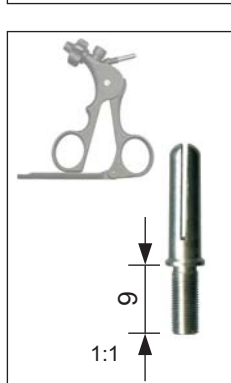
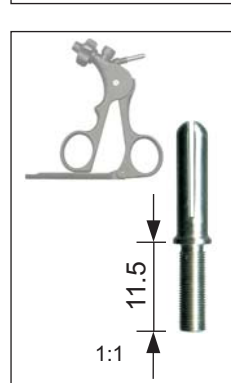
We manufacture handles in accordance with your drawing and / or sample

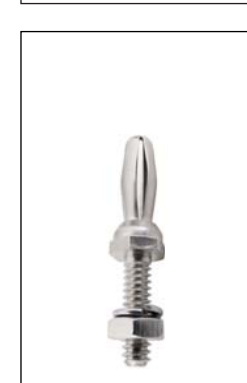
 1:1 6/5.1	 1:1 6/5.2	 1:1 6/5.3	 1:1 6/5.4	 1:1 6/5.5	 1:1 6/5.6
 1:1 6/5.7	 1:1 F-1048 → 6/5.8S → 6/5.8B → 6/5.8	 1:1 6/5.9	 1:1 6/5.10	 1:1 6/5.11	 1:1 6/5.12
 1:1 6/5.13	 1:1 6/5.14	 1:1 6/5.15A	 1:1 6/5.15B	 1:1 6/5.16	 1:1 6/5.17
 1:1 6/5.18	 1:1 9 NP 3-3G1	 1:1 11.5 NP 3-3E1	 1:1 NP 3-5A3	 1:1 6/5.19	 6/5.21

200214 6_5B

Handle post

We manufacture handles in accordance with your drawing and / or sample



Retractor Ratchets

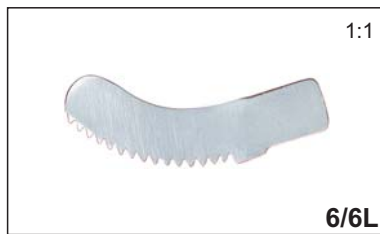
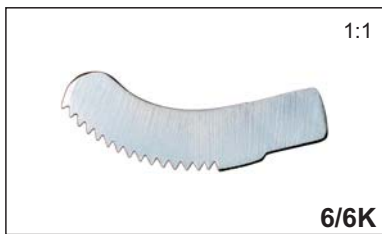
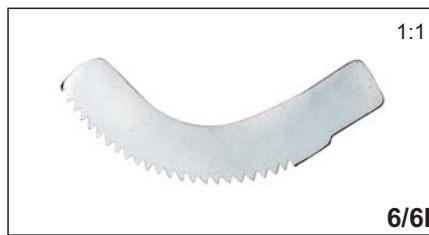
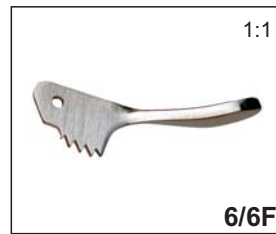
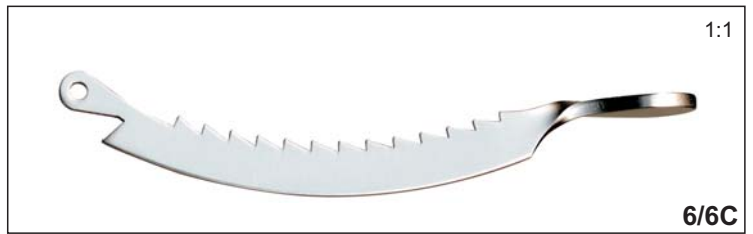
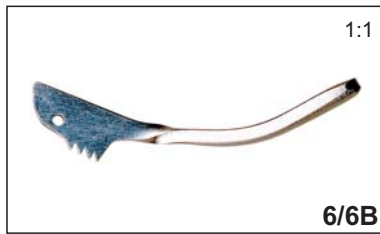
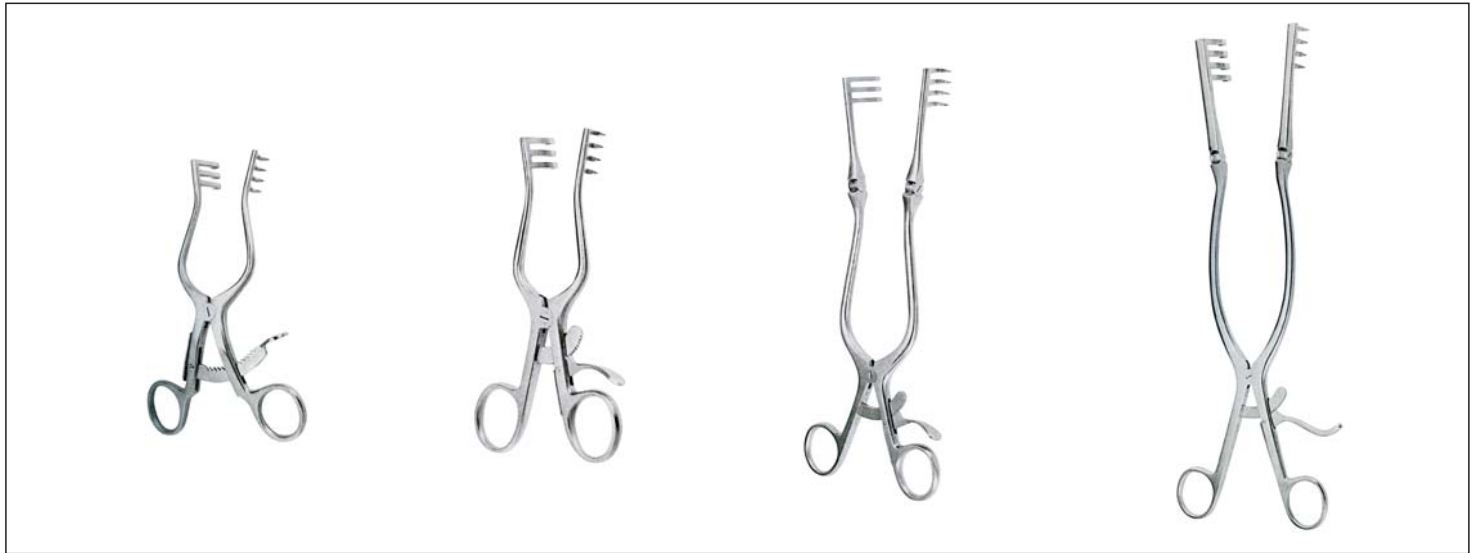

251105 6_6

Screw

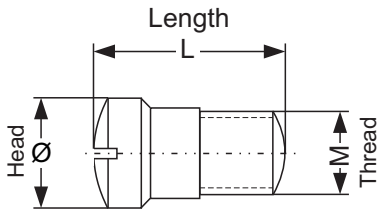















Thread M x ØHead - Length

ask for other sizes!











Scissors



 M1,7 x Ø2,5 - 6,1 L 6/7A	 M2,3 x Ø4 - 6,9 L 6/7AF	 M2 x Ø3,0 - 6 L 6/7B	 M2,3 x Ø3,5 - 6,8 L 6/7C	 M2,5 x Ø3,5 - 5,7 L 6/7CA
 M2,5 x Ø4 - 7,5 L 6/7CB	 M2,6 x Ø4 - 7,7 L 6/7D	 M3 x Ø4,5 - 8,5 L 6/7E	 M3 x Ø5 - 9,2 L 6/7F	 M3,5 x Ø5,5 - 9,5 L 6/7G
 M4 x Ø6 - 9,8 L 6/7H	 M5 x Ø8 - 12 L 6/7I	 M4 x Ø6 - 8,2 L 6/7NN	 M3,35 x 0.6 x Ø4,45 - 9 L 6/7NO	

















Rongeur Forceps



 M3 x Ø4,5 - 8,5 L 6/7J	 M3 x Ø5 - 8,7 L 6/7K	 M3,5 x Ø5,5 - 12,7 L 6/7L	 M4 x Ø6 - 10,5 L 6/7M	 M4 x Ø6 - 8,7 L 6/7N
 M4 x Ø6.5 - 10 L 6/7MC	 M5 x Ø8 - 9 L 6/7O	 M5 x Ø8 - 13 L 6/7P	 M6 x Ø10 - 14 L 6/7Q	 M6 x Ø10 - 14 L 6/7R

Spring and Pin



 M3 x Ø5 - 13 L 6/7AG	 M3 x Ø5 - 7 L 6/7S	 M3 x Ø5 - 5 L 6/7T	 M2,6 x Ø5 - 9 L 6/7U	 M2,6 x Ø5 - 7 L 6/7V	 M2,6 x Ø5 - 6 L 6/7W
 M2,6 x Ø5 - 5 L 6/7WA	 M2,6 x Ø5,5 - 5,5 L 6/7WB	 M2,6 x Ø4,5 - 8 L 6/7WC	 M2,3 x Ø4 - 6,5 L 6/7X	 M2 x Ø4 - 7,5 L 6/7XA	 M2,3 x Ø4 - 3,5 L 6/7XB
 M2,3 x Ø4 - 6,5 L 6/7XC	 M2,3 x Ø4 - 3,5 L 6/7XX	 M2,6 x Ø5 - 4,5 L 6/7Y	 M2,5 x Ø5 - 11 L 6/7YY		

191216 6_7-1A

Screw

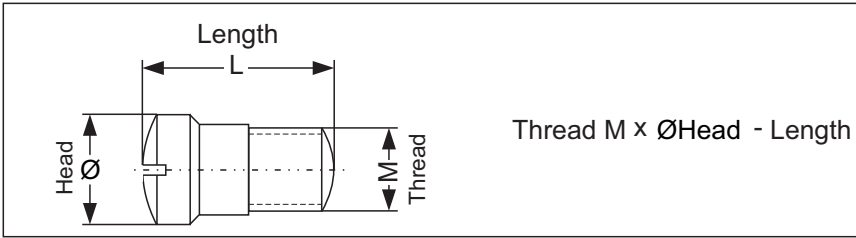

ask for other sizes!

Handle

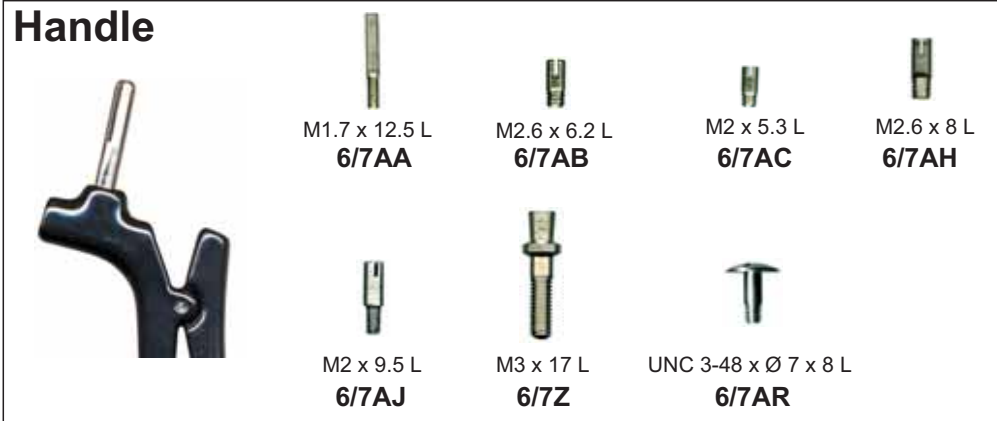

Grasping Forceps



Bipolar Forceps

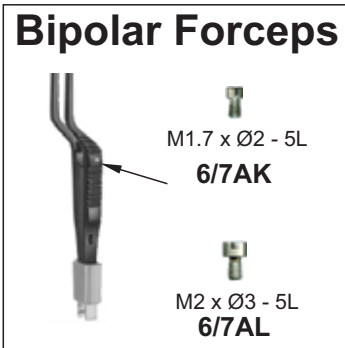

Uterine Biposy Forceps (Kevorkian-Young)

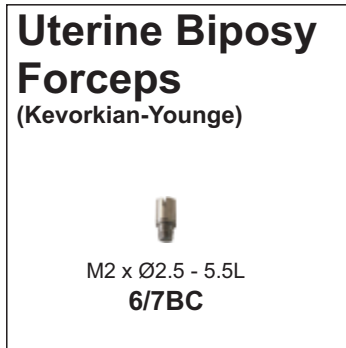

for Micro Instr.

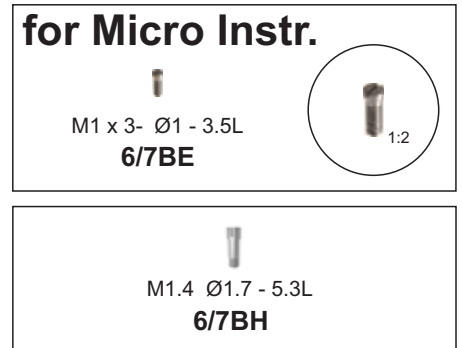

usable for SYNTHES

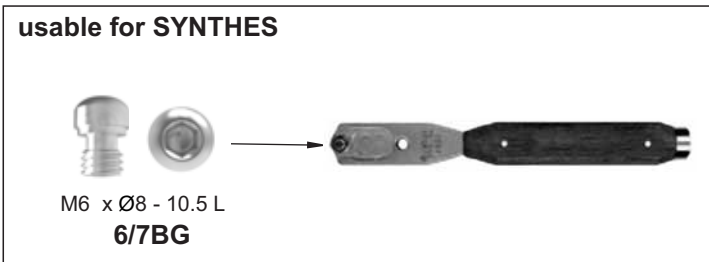

usable for ST

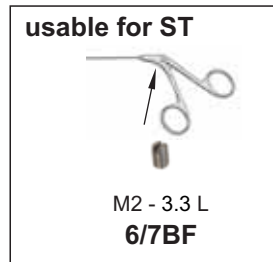

usable for ST

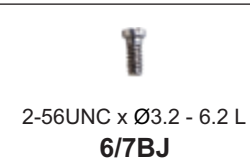
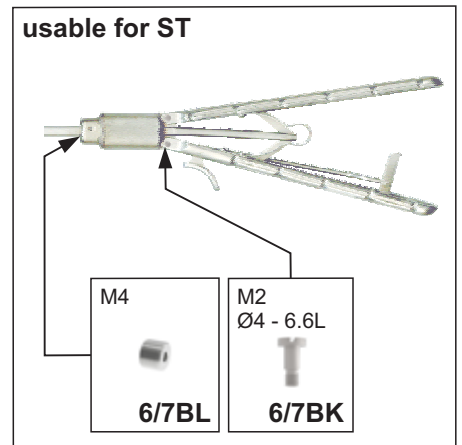

usable for AES

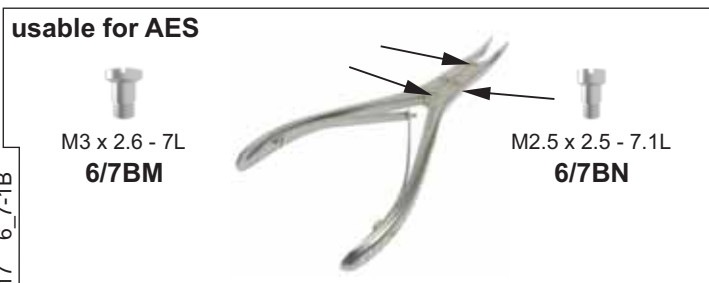

usable for AES

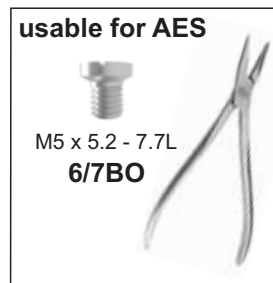

usable for AES



230517 6_7-1B

Screw usable for Kerrison

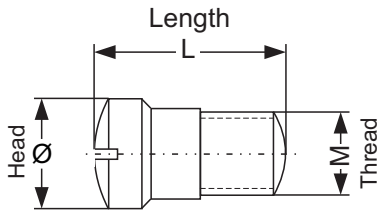

Thread M x ØHead - Length

ask for other sizes!

usable for Kerrison Fehling

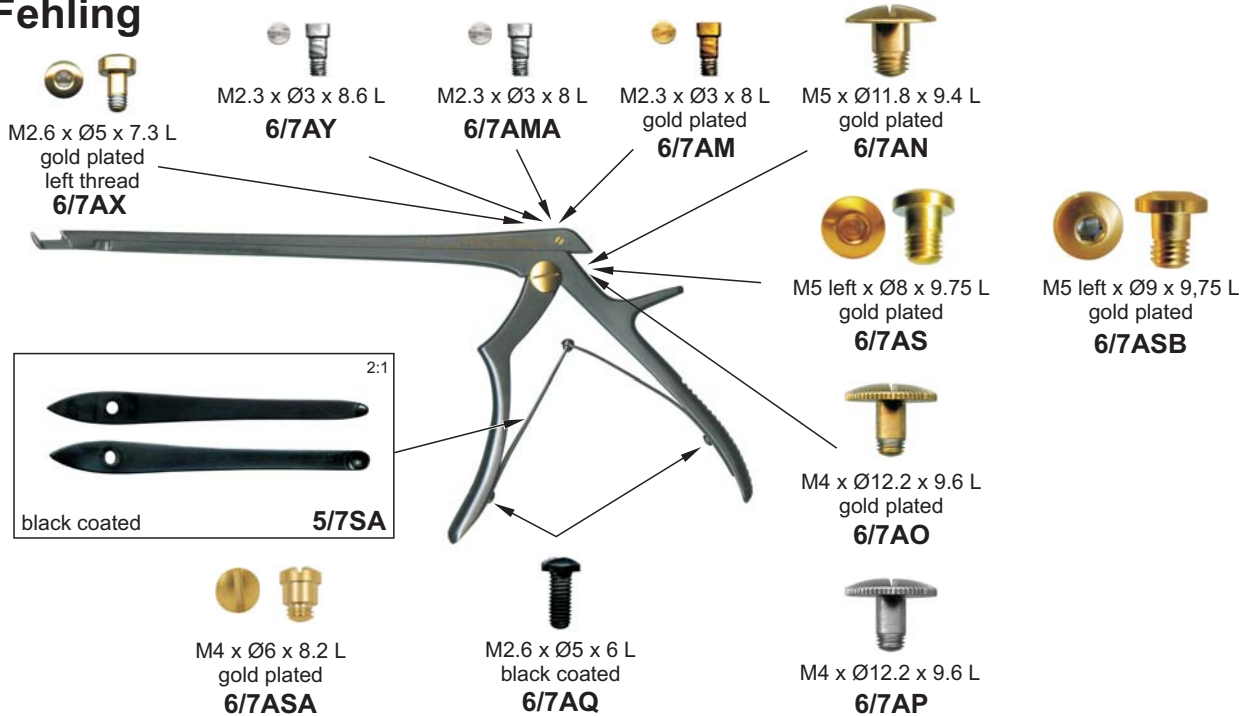

usable for Kerrison left thread

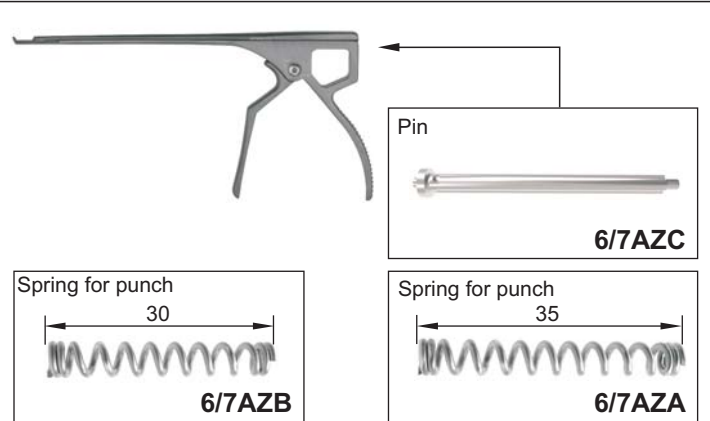
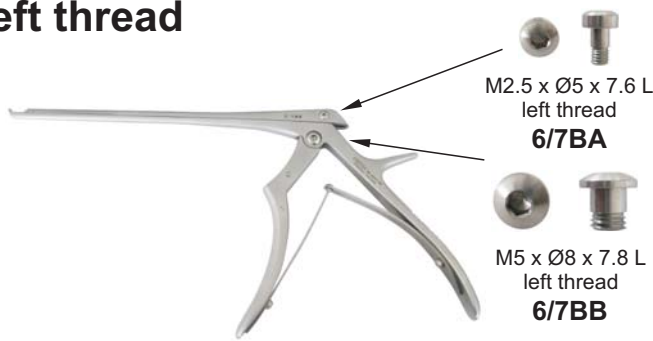

Set for Rongeur

usable for
AES FG824R

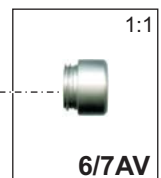
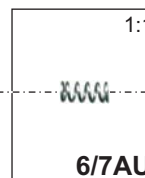
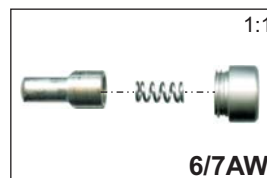

231215 6_7-1C

Screw usable for Rongeurs

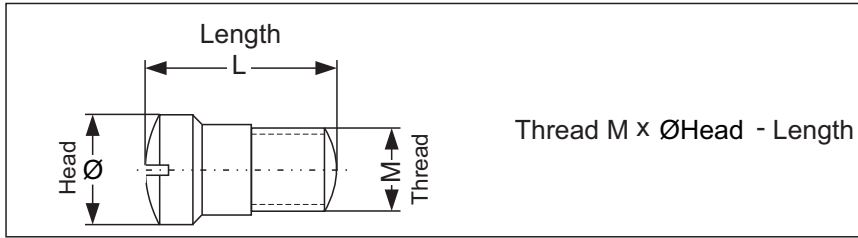

ask for other sizes!

usable for Fehling Rongeurs



Rollet Screw

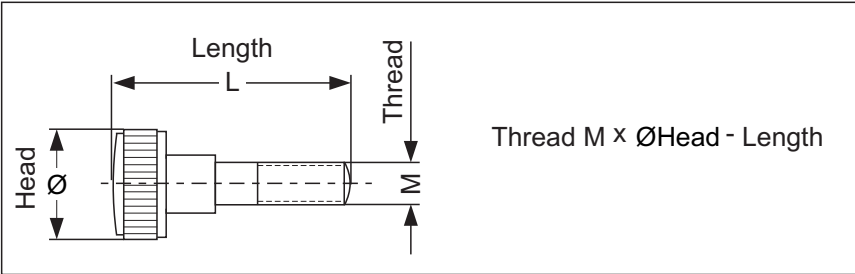

ask for other sizes!

M2 x Ø10 - 12 L 6/8A	M2.5 x Ø10 - 12 L 6/8B	M2.6 x Ø11 - 19 L 6/8C	M3.5 x Ø12 - 11 L 6/8D	M4 x Ø11 - 18 L 6/8E	M4.5 x Ø12.5 - 17 L 6/8F
M4 x Ø13 - 14 L 6/8G	M2.3 x Ø10 - 17.5 L 6/8H	M2.3 x Ø10 - 21 L 6/8HA	M2.5 x Ø10 - 22 L 6/8HB	M2.6 x Ø10 - 22 L 6/8HC	M2.6 x Ø10 - 16 L 6/8I
M2.6 x Ø10 - 14 L 6/8J	M3 x Ø10 - 10 L 6/8K	M3 x Ø11 - 27 L 6/8L	M2 x Ø8 - 16 L 6/8M	M2.6 x Ø10 - 23 L 6/8NA	M2.6 x Ø10 - 23 L 6/8NB
M3 x Ø11 - 15 L 6/8O	M3.5 x Ø12 - 23 L 6/8P	M4.0 x Ø12 - 25 L 6/8PA	M4.5 x Ø12 - 25 L 6/8Q	M3 x Ø10 - 12 L 6/8R	M3 x Ø11 - 23.5 L 6/8S
M2 x Ø7 - 10 L 6/8T	M1.4 x Ø4 - 11 L 6/8U	M1.7 x Ø5 - 7.7 L 6/8V	M1.7 x Ø7 - 9 L 6/8W	M2 x Ø5 - 8 L 6/8X	M2.6 x Ø6 - 7.8 L 6/8Y
M2.6 x Ø8 - 18 L 6/8Z					

140313 6_8A

Rollet Screw for PILLING

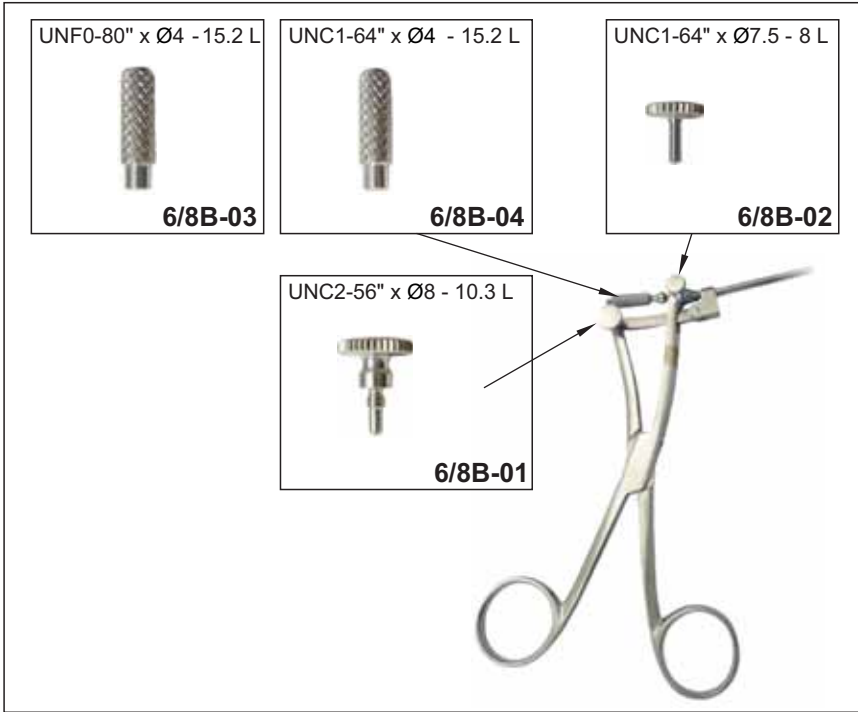
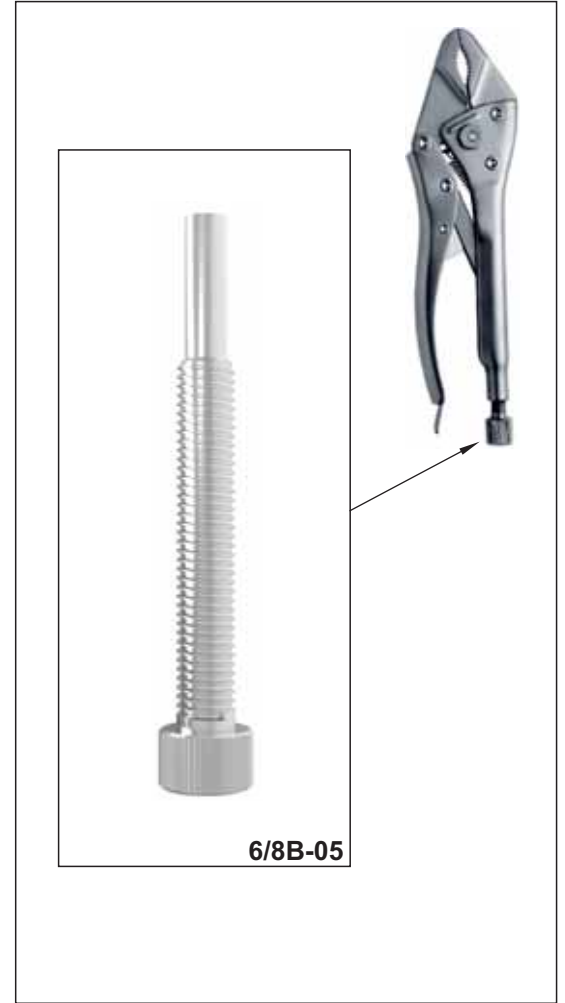
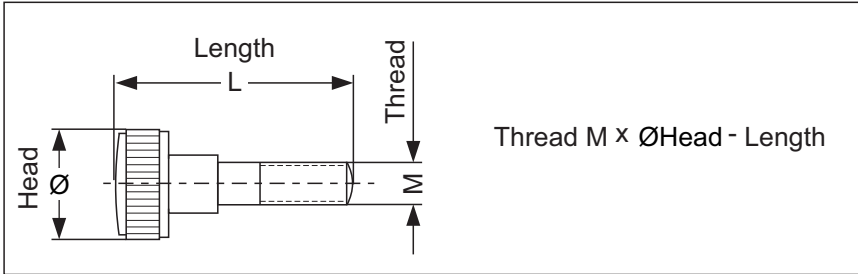

Knurled Nut and Specula Parts

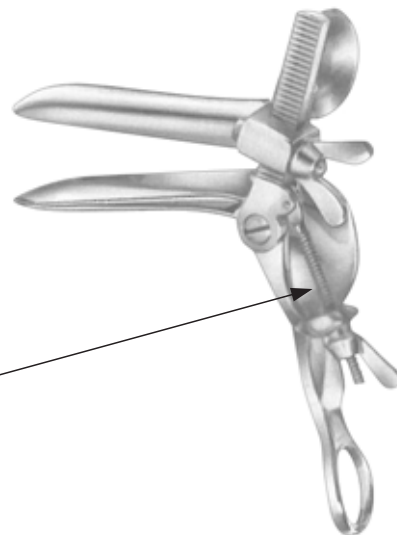
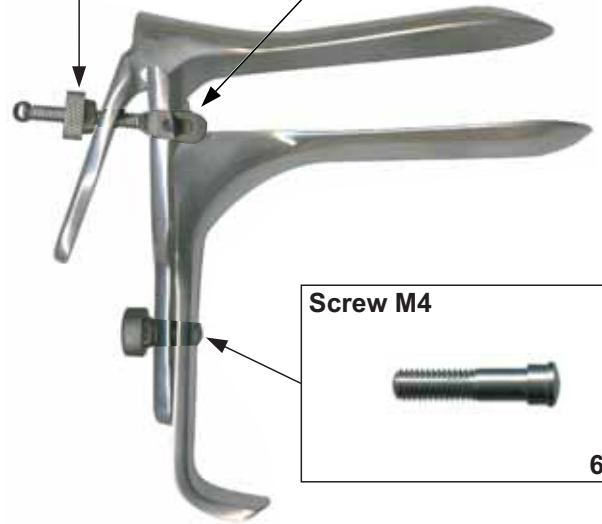

030817 6_09A

Knurled Nut and Bar

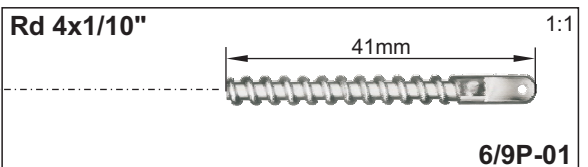
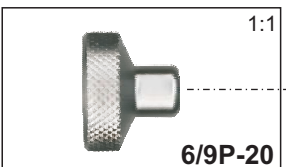
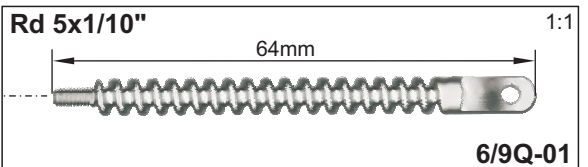
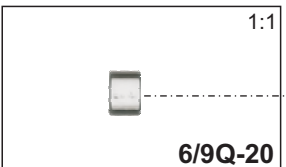
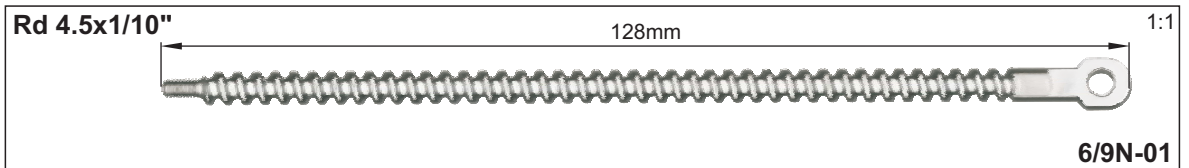
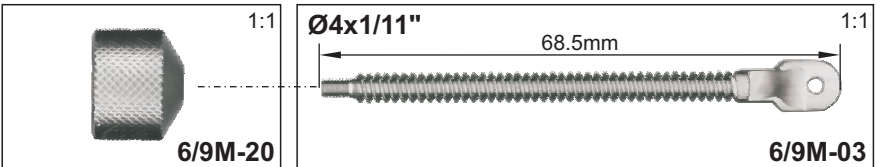
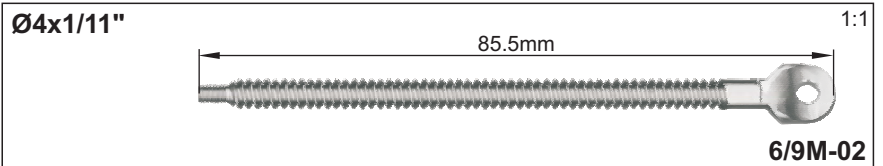
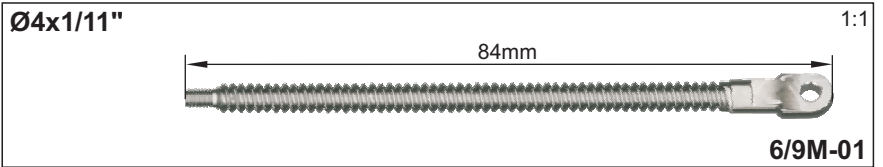
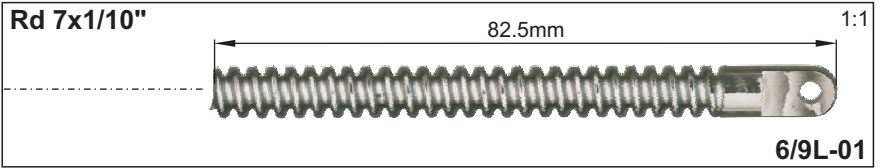
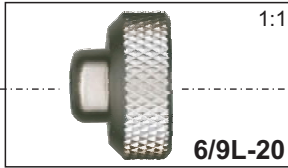
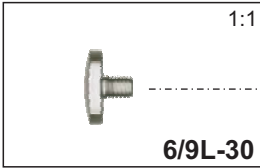
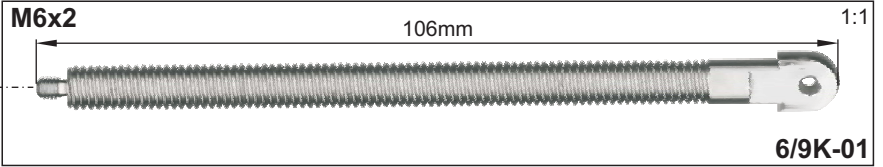
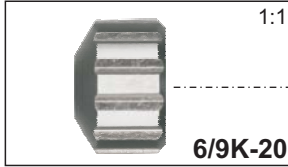
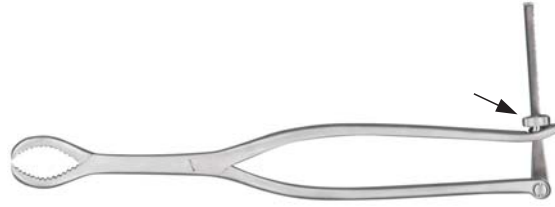

190515 6_09B

Spare parts usable for BoWa Retractor

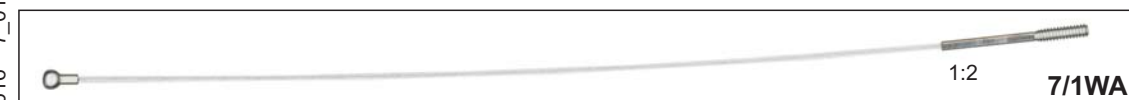
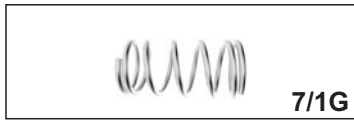
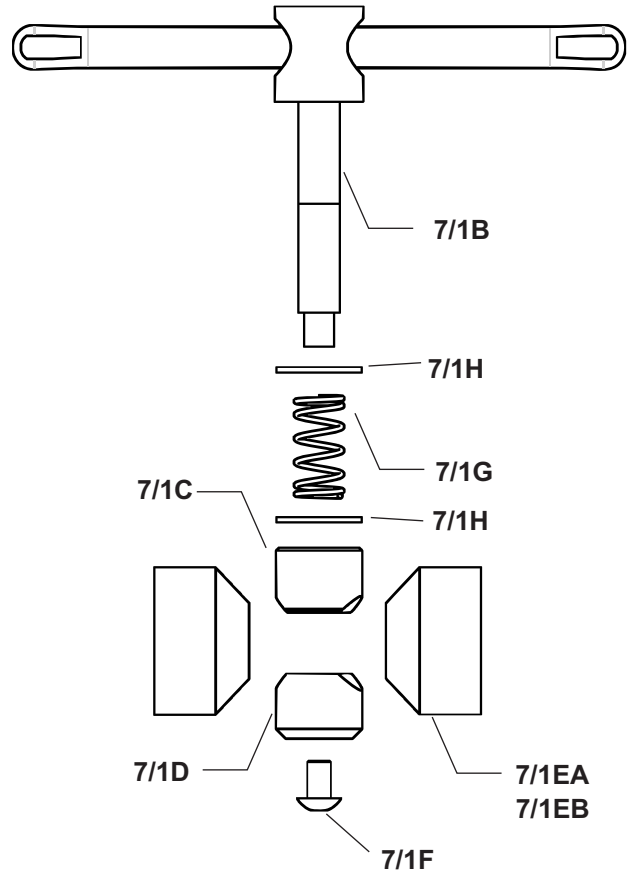

290616 7_01A

© 2016 copyright by DANmed

7/1A

Spare parts usable for BoWa Retractor

BW- Malleable Blades



1½" x 6" **7/1XA**
2" x 6" **7/1XB**
3" x 6" **7/1XC**



1½" x 6" **7/1XA1**
2" x 6" **7/1XB1**
3" x 6" **7/1XC1**



7/1X1

BW- Malleable Blades with Lip



1½" x 6" **7/1XD**
2" x 6" **7/1XE**
3" x 6" **7/1XF**

BW- Kelly Blades



2" x 3" **7/1XG**
2" x 4" **7/1XH**
2" x 5" **7/1XJ**
2" x 6" **7/1XK**

usable for BW- Horizontal Bar



7/1YA



1:2

7/1YB



1:2

7/1YC







191216 7_01B

Spare parts usable for Greenberg Retractor



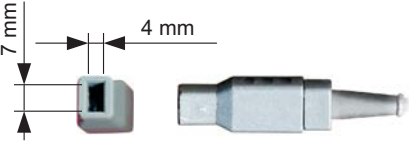
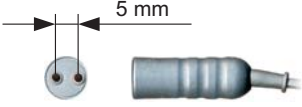
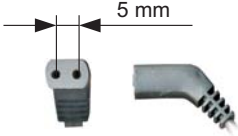

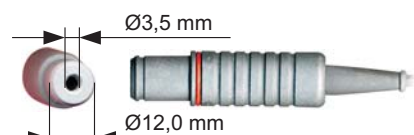

7/2B

Bipolar High Frequency Cable







Instrument connecting	Unit connecting	Length	order-no
 Ø5mm Bip.-Instr.	 Banana Pin- male Ø4 mm (Valleylab)	3 m	LKB-008-063
 Ø3mm Bip.-Instr.		3 m	LKB-008-073
 European Flat Plug female		3 m	LKB-008-103
		5 m	LKB-008-105
 Twin Pin- female straight		3 m	LKB-008-113
		5 m	LKB-008-115
 Twin Pin- female 45°		3 m	LKB-008-123
		5 m	LKB-008-125
 ST- Fischer Connector		3 m	LKB-008-133
		5 m	LKB-008-135
 ST- Kleppinger female	3 m	LKB-008-143	
	5 m	LKB-008-145	
 WO- Kleppinger female	3 m	LKB-008-153	
	5 m	LKB-008-155	

090914 CB.01 Kabel-Bipolar

Bipolar High Frequency Cable

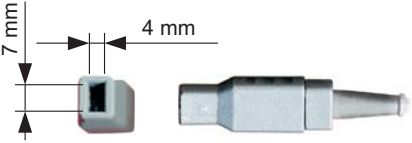
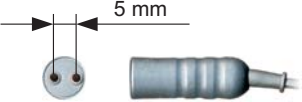

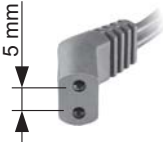
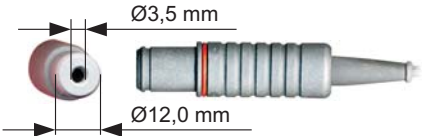

Instrument connecting	Unit connecting	Length	order-no
 Cable- end	 Banana Pin- male Ø4 mm (Valleylab)	3 m	LKB-008-163
		5 m	LKB-008-165
 EU-Flat Plug		3 m	LKB-008-223
		3 m	LKB-008-225
 US-2-Pin Plug		3 m	LKB-008-233
		3 m	LKB-008-235
 Y 2/2 stufiger Stecker mit O-Ring		3 m	LKB-008-263
		3 m	LKB-008-265

Bipolar High Frequency Cable



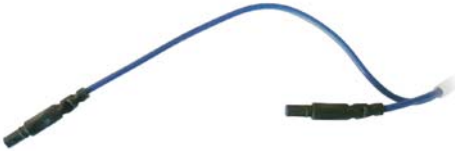

Instrument connecting	Unit connecting	Length	order-no
 Ø5mm Bip.-Instr.		3 m	LKB-009-063
 Ø3mm Bip.-Instr.		3 m	LKB-009-073
 European Flat Plug female		3 m	LKB-009-103
		5 m	LKB-009-105
 Twin Pin- female straight		3 m	LKB-009-113
	 ERBE Generator female	5 m	LKB-009-115
		3 m	LKB-009-123
 US-Twin Plug		5 m	LKB-009-125
		3 m	LKB-009-143
 ST- Kleppinger female		5 m	LKB-009-145
		3 m	LKB-009-153
 WO- Kleppinger female		5 m	LKB-009-155
		3 m	LKB-009-223
 EU-Flat Plug		5 m	LKB-009-225

090914 CB.03 Kabel-Bipolar

Bipolar High Frequency Cable



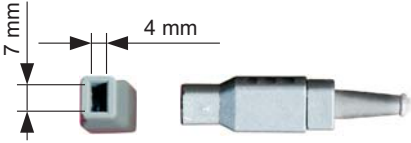
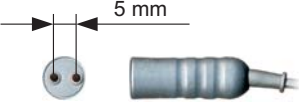
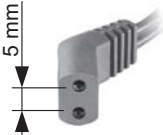





Instrument connecting	Unit connecting	Length	order-no
 US-2-Pin Plug	 ERBE Generator female	3 m	LKB-009-233
		5 m	LKB-009-235
 AES scissor connector		5 m	LKB-009-245
 AAG Flach		3 m	LKB-009-253
 2x2,65mm FKBU		3 m	LKB-009-283

Bipolar High Frequency Cable

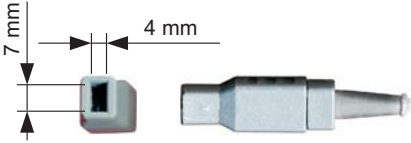
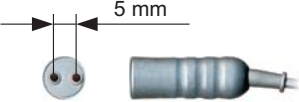
Instrument connecting	Unit connecting	Length	order-no
 Ø5mm Bip.-Instr.	 Martin Generator	3 m	LKB-010-063
 Ø3mm Bip.-Instr.		3 m	LKB-010-073
 European Flat Plug female		3 m	LKB-010-103
		5 m	LKB-010-105
 Twin Pin- female straight		3 m	LKB-010-113
		5 m	LKB-010-115
 US-Twin Plug		3 m	LKB-010-123
		5 m	LKB-010-125
 EU-Flat Plug		3 m	LKB-010-223
		5 m	LKB-010-225
 US-2-Pin Plug	3 m	LKB-010-233	
	5 m	LKB-010-235	

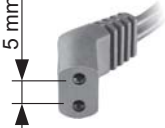





090914 CB 05_Kabel+Bipolar

Bipolar High Frequency Cable

Instrument connecting	Unit connecting	Length	order-no
 Ø5mm Bip.-Instr.		3 m	LKB-011-063
 Ø3mm Bip.-Instr.		3 m	LKB-011-073
 European Flat Plug female		3 m	LKB-011-103
		5 m	LKB-011-105
 Twin Pin- female straight	 2 Pin- male (Valleylab) Ø4 mm	3 m	LKB-011-113
		5 m	LKB-011-115
 US-Twin Plug		3 m	LKB-011-123
		5 m	LKB-011-125
 WO- Kleppinger female		3 m	LKB-011-153
		5 m	LKB-011-155
 EU-Flat Plug		3 m	LKB-011-223
		5 m	LKB-011-225
 US-2-Pin Plug		3 m	LKB-011-233
		5 m	LKB-011-235

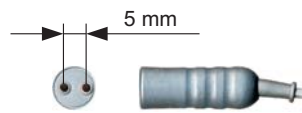
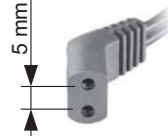
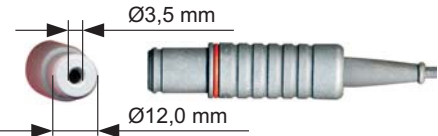













090914 CB.06 Kabel-Bipolar

Bipolar High Frequency Cable

Instrument connecting	Unit connecting	Length	order-no
 <p>European Flat Plug female</p>	 <p>WO- Generator</p>	3 m	LKB-012-103
		5 m	LKB-012-105
 <p>Twin Pin- female straight</p>		3 m	LKB-012-113
		5 m	LKB-012-115
 <p>US-Twin Plug</p>		3 m	LKB-012-123
		5 m	LKB-012-125
 <p>ST- Kleppinger female</p>		3 m	LKB-012-143
		5 m	LKB-012-145
 <p>WO- Kleppinger female</p>		3 m	LKB-012-153
		5 m	LKB-012-155
 <p>Cable- end</p>	5 m	LKB-012-165	
 <p>EU-Flat Plug</p>	3 m	LKB-012-223	
	5 m	LKB-012-225	
 <p>US-2-Pin Plug</p>	3 m	LKB-012-233	
	5 m	LKB-012-235	



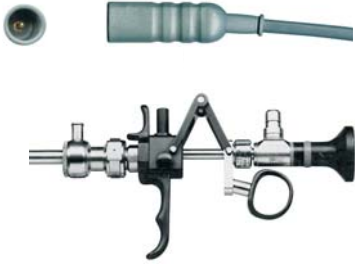

090914 CB.07 Kabel-Bipolar

Monopolar High Frequency Cable

Instrument connecting	Unit connecting	Length	order-no
 Straight single pin- female Ø4mm	 Bovie plug- male Ø8mm / Valleylab / Erbe Int.	3 m	LKM-002-013
		5 m	LKM-002-015
 Straight single pin- female Ø4mm	 Banana Pin- male Ø4mm (Valleylab)	3 m	LKM-001-013
		5 m	LKM-001-015
 Banana pin- male Ø4mm (Valleylab)	 Banana Pin- male Ø4mm (Valleylab)	3 m	LKM-001-043
		5 m	LKM-001-045
 WO- Resectoscopes	 Banana Pin- male Ø4mm (Valleylab)	3 m	LKM-001-213
		5 m	LKM-001-215
 Right angle Single Pin- female Ø4mm	 Bovie plug- male Ø8mm / Valleylab / Erbe Int.	3 m	LKM-002-203
		5 m	LKM-002-205
 Banana Pin- male Ø4mm (Valleylab)	 Bovie plug- male Ø8mm / Valleylab / Erbe Int.	3 m	LKM-002-043
		5 m	LKM-002-045
 WO- Resectoscopes	 Bovie plug- male Ø8mm / Valleylab / Erbe Int.	3 m	LKM-002-213
		5 m	LKM-002-215

220611 CM 01_Kabel

Monopolar High Frequency Cable

Instrument connecting	Unit connecting	Length	order-no
 Angeled Plug	 Banana Pin- male Ø4mm (Valleylab)	3 m	LKM-001-183
		5 m	LKM-001-185
 Straight Plug	 Banana Pin- male Ø4mm (Valleylab)	3 m	LKM-001-193
		5 m	LKM-001-195

111110 CM 02_Kabel-Monopolar

Container Tools

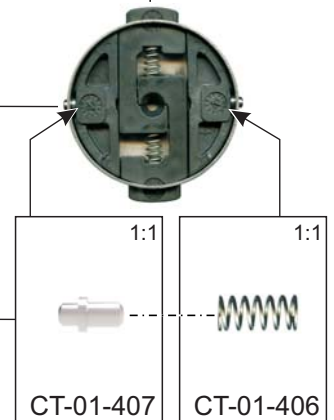
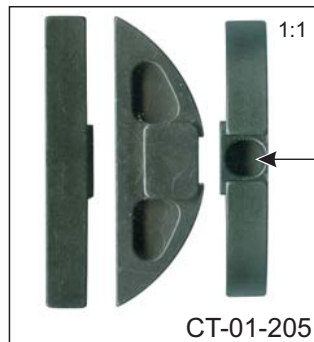
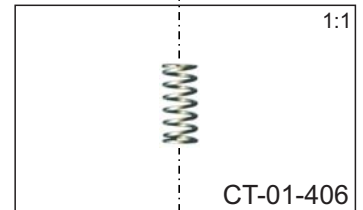
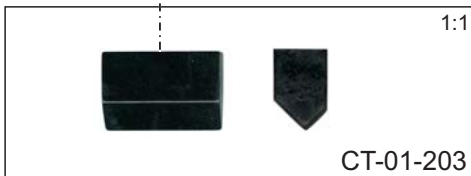
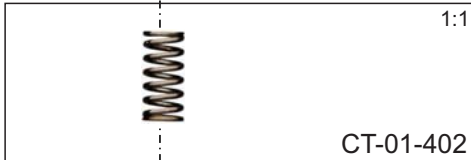
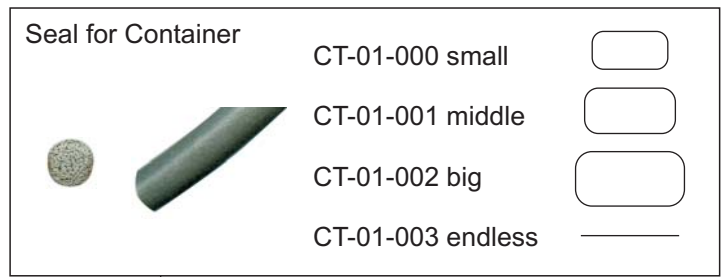
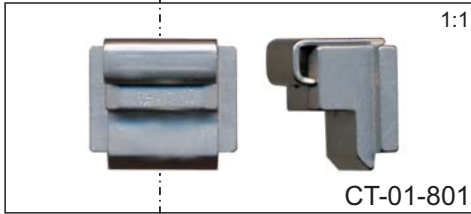
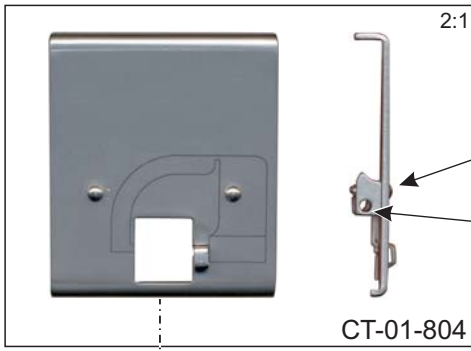

170616 CT_01

Container Tools

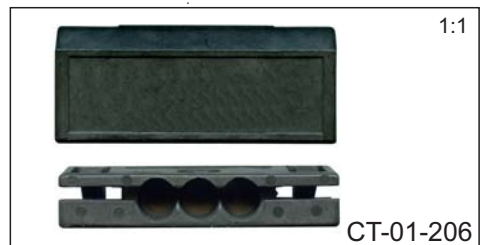
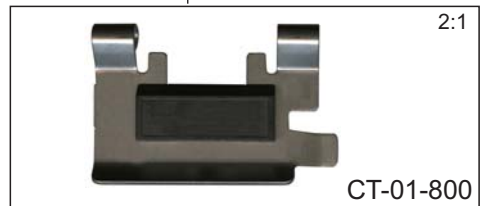
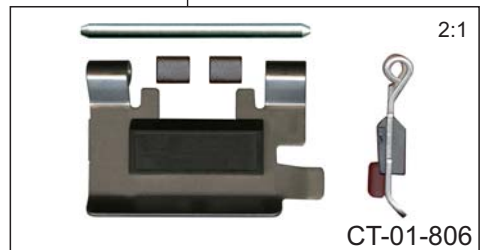
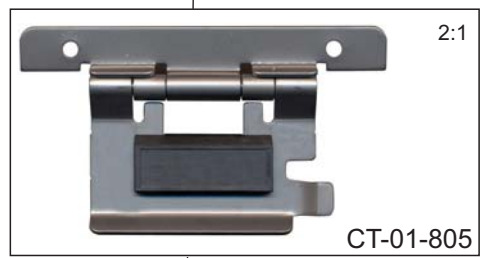
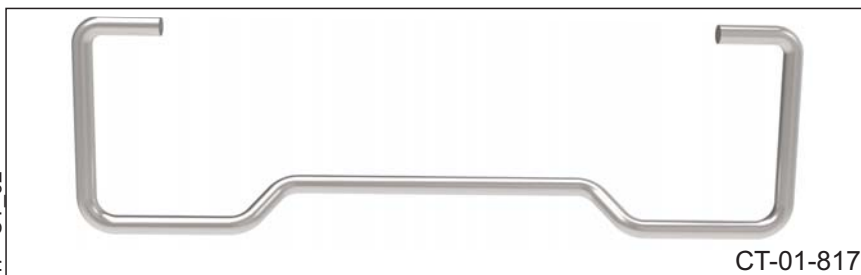
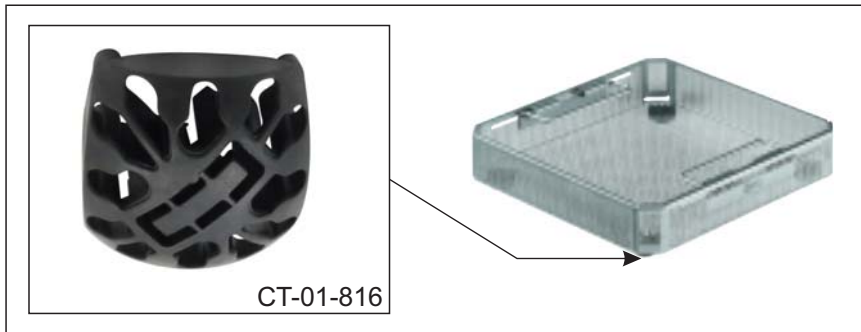
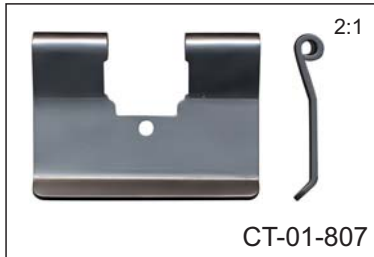

080317 CT_02

Container Tools usable for GENESIS Container

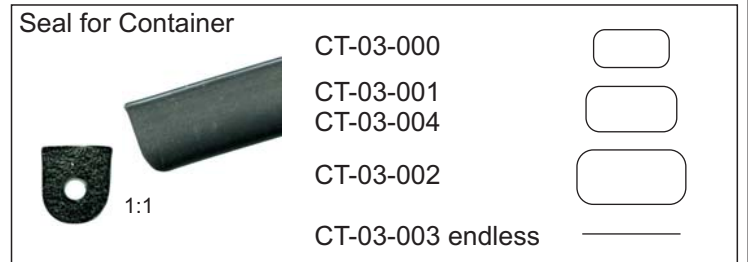
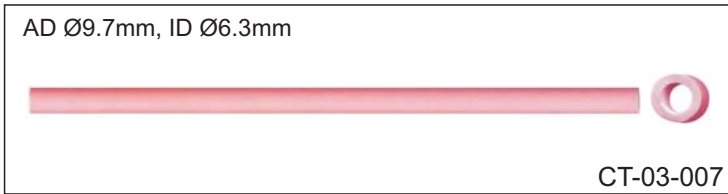
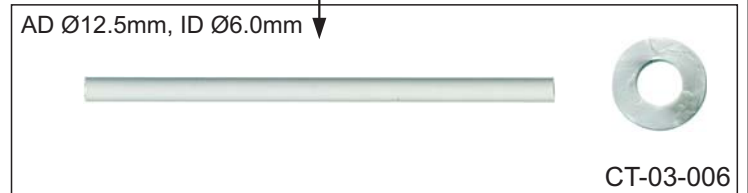
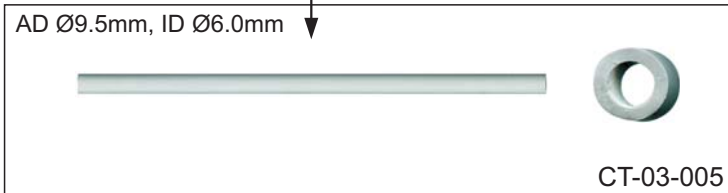
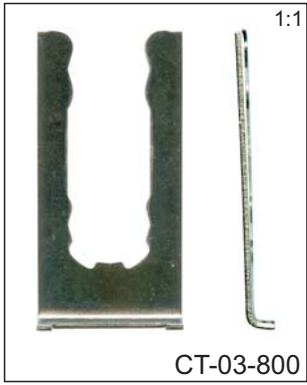

110216 CT_03

Container Tools, usable for Wagner Container

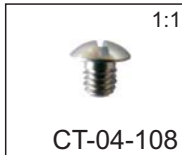
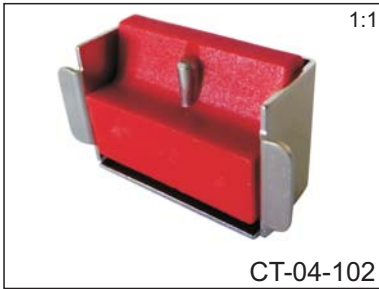

Container Tools, usable for Wagner Container



Container Tools

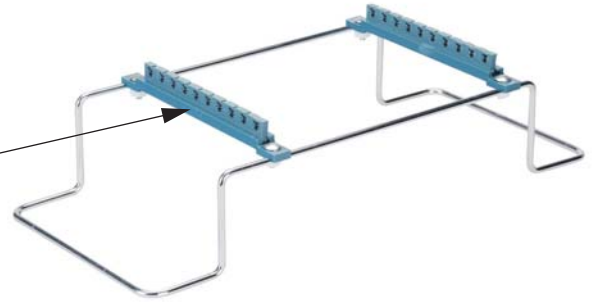
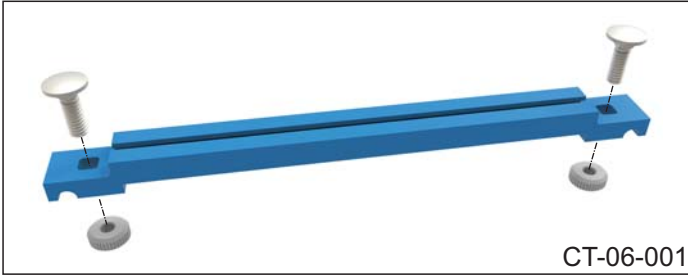

Insulation Continuity Tester and equipment

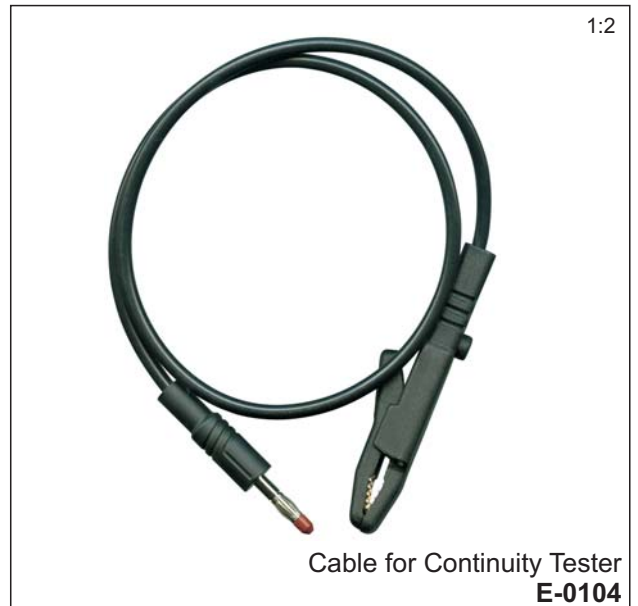

17042013 Z-E_02

Insulation Continuity Tester and equipment

eQ Tester set



TESTING OF

- neutral, monopolar and bipolar connection lines
- dispersive electrodes
- handles with two finger switch
- insulation of tubular shank instruments
- bipolar and monopolar forceps

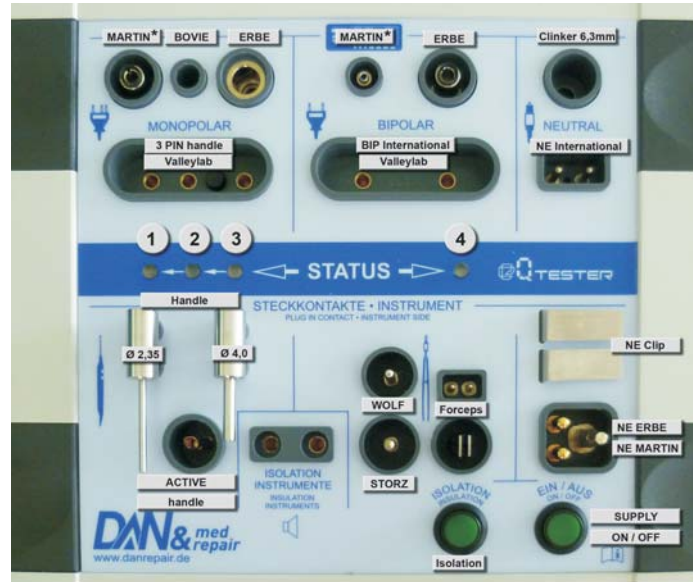

E-0104
Connection cable



LKM-001-013
Monopolar cable
Erbe T-Serie, Martin,
Berchtold, 3m



E-0102 E-0103
Touch Pads



E-0101
Touch Pad liquid

eQ Tester set
E-0110



Case f. eQ Tester
E-0113

241114 Z-E_03

Flexible Parts

Stopper Pin

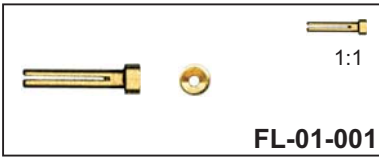
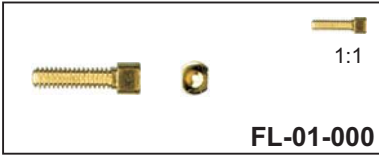

Biopsy Channel Port 1:1



Biopsy Channel Port



Bremsfitting 1:1



Marking Ring 1:1



Marking Pin 1:2

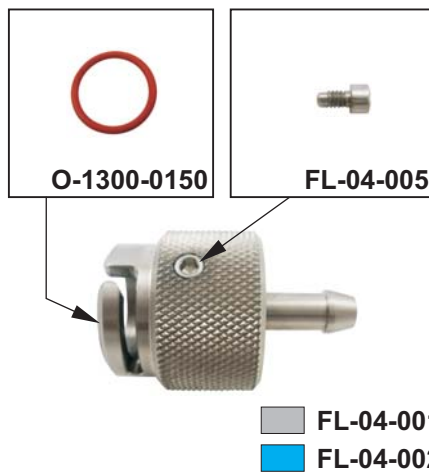

Opening tool usable for OLY Flexible Scope

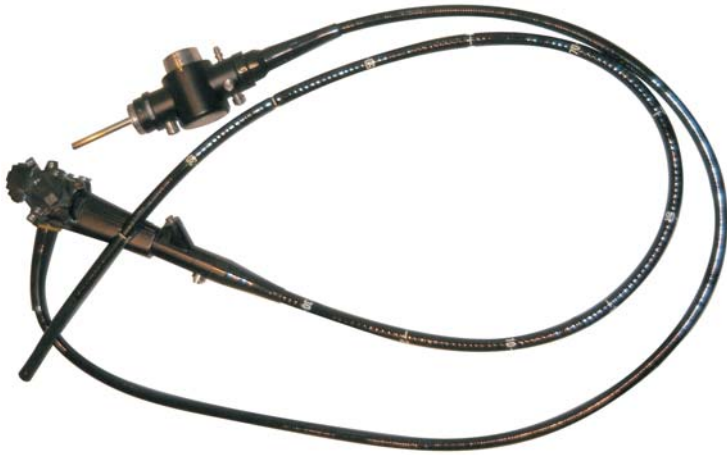

Tool 2 in 1

1:1



FLT-01-100

Tool for Grip Housing

1:1



FLT-01-101

Screw for Grip Housing

1:1



M2,6 x Ø5 - 6 L

6/7W

Tool for Side Cover

1:1



FLT-01-102

Screw for Side Cover

1:1



M2,6 x Ø5 - 9 L

6/7U

POWER-TOOL

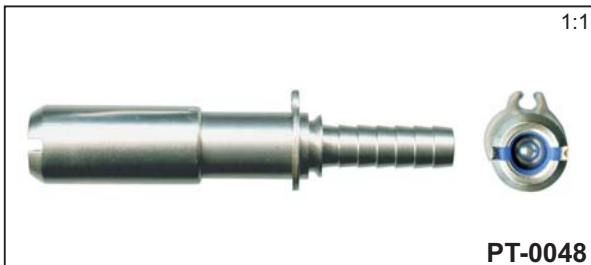
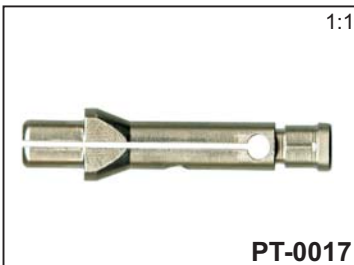
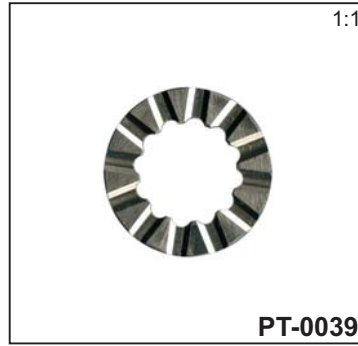
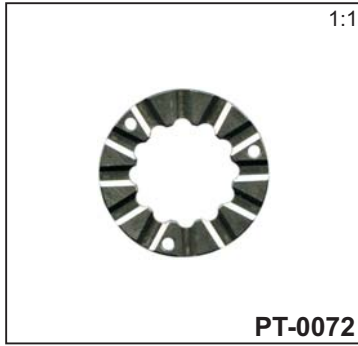

161115 Z-PT_01

POWER-TOOL

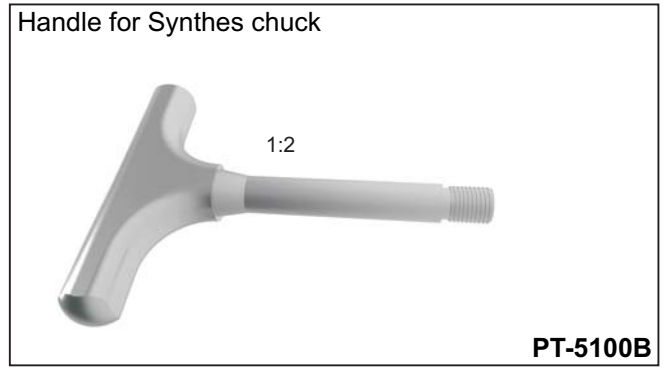
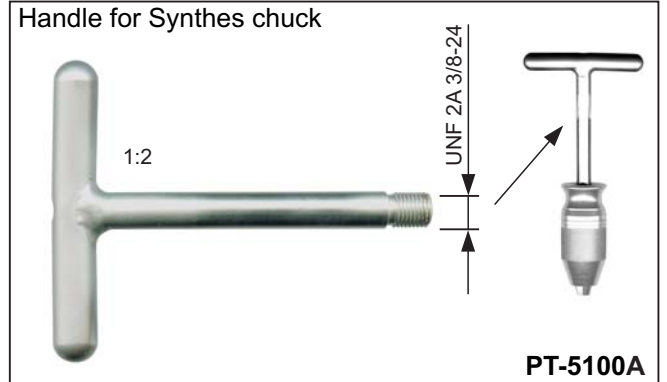
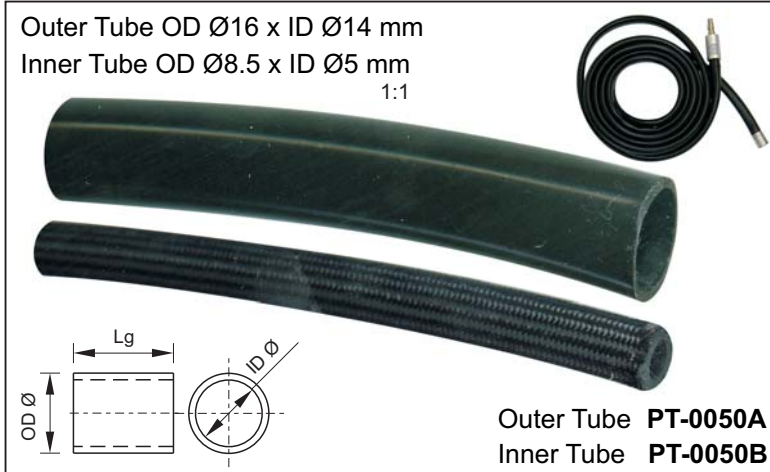
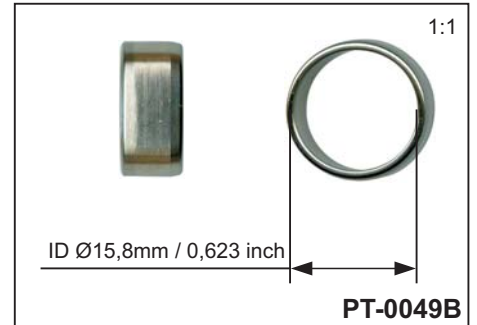
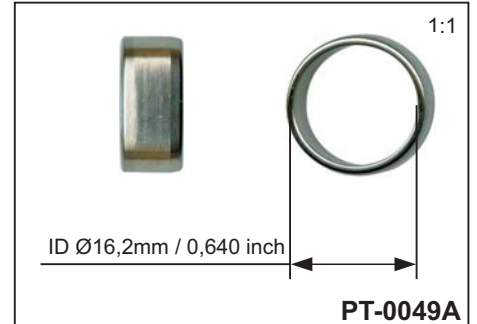
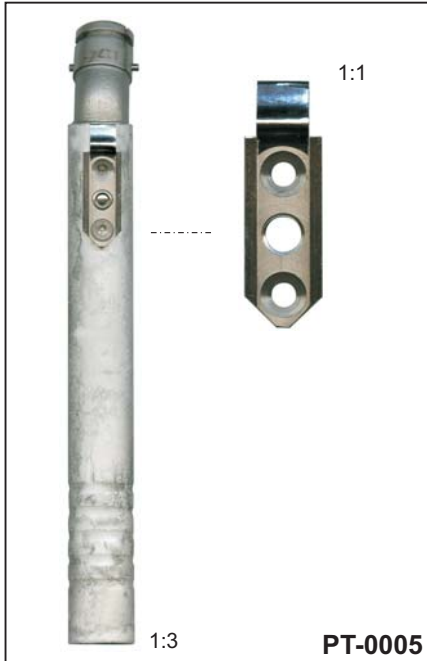

300714 Z-PT_02

Stainless Steel Drill Chucks

for Hand, Power & Air Surgical Instruments



*L1 = open length
*L2 = close length

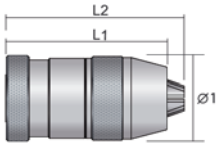

usable for Albrecht

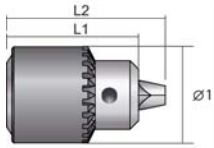

usable for Jacobs

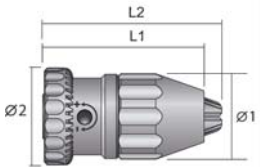

Keyless	Capacity				Dimensions mm			Weight	
	Order No.	mm	inches	mount	key	Ø1	L1*		L2*
nose and collar have knurled sections ; no bead blast									
PTS-036-330	0.3-6.5	.012-.250	3/8-24	-		33,6	62,3	69,6	300

Keyed	Capacity				Dimensions mm			Weight	
	Order No.	mm	inches	mouth	key	Ø1	L1*		L2*
bead blasted sleeve									
PTK-057-280	0.5-7.4	.020-.291	J-1	K1M		28,4	40,0	50,3	110
PTK-057-281	0.5-7.4	.020-.291	3/8-24	K1M		28,4	40,0	50,3	110
PTK-057-282	0.5-7.4	.020-.291	5/16-24	K1M		28,4	40,0	50,3	100

Hybrid	Capacity				Dimensions mm				Weight	
	Order No.	mm	inches	mouth	key	Ø1	Ø2	L1*		L2*
HYBRID is a combined Keyless & Keyed chuck, supplied with the Super-Grip Stainless Key.										
PTH-037-300	0.3-7.4	.012-.291	J-1	K1T		30	34	585,0	65,0	220
PTH-037-301	0.3-7.4	.012-.291	3/8-24	K1T		30	34	56,5	63,0	220

O-Rings

ID 1,42 mm / 0,05 inch
OD 4,46 mm / 0.18 inch



O-0142-0152R

ID 1,5 mm / 0.06 inch
OD 3,5 mm / 0.14 inch



O-0150-0100R

ID 2,4 mm / 0.09 inch
OD 4,5 mm / 0.18 inch



O-0240-0105R

ID 2,5 mm / 0.10 inch
OD 4,5 mm / 0.18 inch



O-0250-0100B

ID 2,8 mm / 0.11 inch
OD 4,8 mm / 0.19 inch



O-0280-0100R

ID 3,0 mm / 0.12 inch
OD 5,0 mm / 1.97 inch



O-0300-0100B

ID 3,0 mm / 0.12 inch
OD 7,0 mm / 0.28 inch



O-0300-0200R

ID 3,5 mm / 0.14 inch
OD 4,5 mm / 0.18 inch



O-0350-0050S

ID 4,0 mm / 0.16 inch
OD - 5,2 mm / 0.20 inch



O-0400-0060S

ID 4,0 mm / 0.16 inch
OD 6,0 mm / 0.24 inch



O-0400-0100R

ID 4,0 mm / 0.16 inch
OD 7,0 mm / 0.28 inch



O-0400-0150S

ID 4,0 mm / 0.16 inch
OD 7,0 mm / 0.28 inch



O-0400-0150R

ID 4,0 mm / 0.16 inch
OD 8,0 mm / 0.31 inch



O-0400-0200R

ID 4,4 mm / 0.17 inch
OD 8,0 mm / 0.31 inch



O-0440-0180R

ID - 4,5 mm / 0.18 inch
OD - 6,7 mm / 0.23 inch



O-0450-0110R

ID 4,5 mm / 0.18 inch
OD - 7,5 mm / 0.30 inch



O-0450-0150S

ID 4,6 mm / 0.18 inch
OD 7,8 mm / 0.31 inch



O-0460-0160R

ID 4,87 mm / 0.19 inch
OD 8,47 mm / 0.33 inch



O-0487-0180B

ID 5,0 mm / 0.20 inch
OD 7,0 mm / 0.28 inch



O-0500-0100R

ID 5,0 mm / 0.20 inch
OD 9,0 mm / 0.34 inch



O-0500-0200B

ID 5,5 mm / 0.22 inch
OD 9,5 mm / 0.37 inch



O-0550-0200S

ID 6,0 mm / 0.24 inch
OD 8,0 mm / 0.31 inch



O-0600-0100S

ID 6,0 mm / 0.24 inch
OD 9,0 mm / 0.35 inch



O-0600-0150R

ID 6,0 mm / 0.24 inch
OD 9,6 mm / 0.38 inch



O-0600-0180S

ID 6,07 mm / 0.24 inch
OD 9,63 mm / 0.37 inch



O-0607-0178R

ID 6,6 mm / 0.26 inch
OD 10,2 mm / 0.40 inch



O-0660-0180S

ID 7,0 mm / 0.28 inch
OD 10,0 mm / 0.39 inch



O-0700-0150G

ID 7,0 mm / 0.28 inch
OD 10,0 mm / 0.39 inch



O-0700-0150S

ID 7,0 mm / 0.28 inch
OD 11,0 mm / 0.43 inch



O-0700-0200BR

ID 7,0 mm / 0.28 inch
OD 13,0 mm / 0.51 inch



O-0700-0300S

ID 7,5 mm / 0.30 inch
OD 12,5 mm / 0.50 inch



O-0750-0250S

ID 7,65 mm / 0.30 inch
OD 11,21 mm / 0.44 inch



O-0765-0178R

ID 8,0 mm / 0.31 inch
OD 10 mm / 0.39 inch



O-0800-0100S

ID 8,5 mm / 0.33 inch
OD 10,5 mm / 0.41 inch



O-0850-0100R

ID 9,0 mm / 0.35 inch
OD 11,0 mm / 0.43 inch



O-0900-0100R

ID 9,0 mm / 0.35 inch
OD 12,0 mm / 0.47 inch



O-0900-0150S

ID 9,0 mm / 0.35 inch
OD 16,0 mm / 0.63 inch



O-0900-0350S

ID 9,1 mm / 0.36 inch
OD 16,2 mm / 0.64 inch



O-0910-0355S

ID 9,12 mm / 0.36 inch
OD 16,18 mm / 0.64 inch



O-0912-0353R

ID 10,0 mm / 0.39 inch
OD 11,2 mm / 0.44 inch



O-1000-0060R

ID 10,0 mm / 0.39 inch
OD 12,0 mm / 0.47 inch



O-1000-0100R

ID 10,0 mm / 0.39 inch
OD 12,5 mm / 0.49 inch



O-1000-0125S

ID 10,0 mm / 0.39 inch
OD 12,6 mm / 0.49 inch



O-1000-0130R

ID 10,0 mm / 0.39 inch
OD 13,1 mm / 0.52 inch



O-1000-0155BR

ID 10,0 mm / 0.39 inch
OD 13,0 mm / 0.51 inch



O-1000-0150S

ID 10,0 mm / 0.39 inch
OD 13,0 mm / 0.51 inch



O-1000-0150R

O-Rings

ID 10,0 mm / 0.39 inch
OD 16,0 mm / 0.63 inch



O-1000-0300B

ID 10,0 mm / 0.39 inch
OD 16,0 mm / 0.63 inch



O-1000-0300S

ID 10,8 mm / 0.43 inch
OD 13,8 mm / 0.54 inch



O-1080-0150S

ID 11,0 mm / 0.43 inch
OD 13,0 mm / 0.51 inch



O-1100-0100R

ID 11,0 mm / 0.43 inch
OD 13,6 mm / 0.54 inch



O-1100-0130R

ID 11,0 mm / 0.43 inch
OD 13,6 mm / 0.54 inch



O-1100-0130S

ID 11,0 mm / 0.43 inch
OD 14,0 mm / 0.55 inch



O-1100-0150R

ID 11,0 mm / 0.43 inch
OD 14,0 mm / 0.55 inch



O-1100-0150S

ID - 11,3 mm / 0.44 inch
OD - 16,1 mm / 0.63 inch



O-1130-0240S

ID 12,0 mm / 0.47 inch
OD 14,0 mm / 0.55 inch



O-1200-0100S

ID - 12,0 mm / 0.47 inch
OD - 14,0 mm / 0.55 inch



O-1200-0100R

ID 12,0 mm / 0.47 inch
OD 14,4 mm / 0.57 inch



O-1200-0120S

ID 13,0 mm / 0.51 inch
OD 15,0 mm / 0.59 inch



O-1300-0100R

ID 13,0 mm / 0.51 inch
OD 16,0 mm / 0.63 inch



O-1300-0150R

ID 13,0 mm / 0.51 inch
OD 16,0 mm / 0.63 inch



O-1300-0150S

ID 14,0 mm / 0.55 inch
OD 16,0 mm / 0.63 inch



O-1400-0100R

ID 14,0 mm / 0.55 inch
OD 17,0 mm / 0.67 inch



O-1400-0150R

ID 14,0 mm / 0.55 inch
OD 19,0 mm / 0.75 inch



O-1400-0250S

ID 15,0 mm / 0.59 inch
OD 18,0 mm / 0.71 inch



O-1500-0150R

ID 15,0 mm / 0.59 inch
OD 18,0 mm / 0.71 inch



O-1500-0150S

ID 19,0 mm / 0.75 inch
OD 24,0 mm / 0.94 inch



O-1900-0250S

ID 21,2 mm / 0.83 inch
OD 24,0 mm / 0.94 inch



O-2120-0140R

ID 23,0 mm / 0.91 inch
OD 26,0 mm / 1.02 inch



O-2300-0150R

ID 25,0 mm / 0.98 inch
OD 28,0 mm / 1.10 inch



O-2500-0150R

ID 25,07 mm / 0.99 inch
OD 30,31 mm / 1,19 inch



O-2507-0262S

ID 28,0 mm / 1.10 inch
OD 31,0 mm / 1.22 inch



O-2800-0150R

ID 30,0 mm / 1.18 inch
OD 33,0 mm / 1.30 inch



O-3000-0150R

O-Rings



ID - 1,5 mm / 0.06 inch
OD - 3,5 mm / 0.14 inch



O-0150-0100R

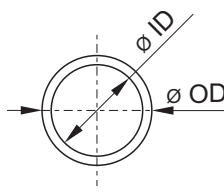

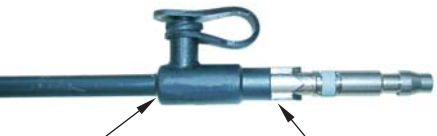

ID - 3,0 mm / 0.12 inch
OD - 5,0 mm / 1.97 inch



O-0300-0100B

ID - 2,5 mm / 0.98 inch
OD - 4,5 mm / 0.18 inch



O-0250-0100B



ID - 10,0 mm / 0.39 inch
OD - 12,0 mm / 0.47 inch



O-1000-0100R

usable for Stryker

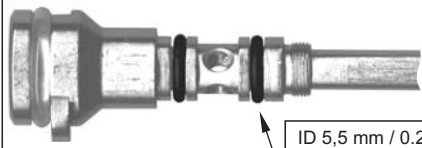

ID 5,5 mm / 0.22 inch
OD 9,5 mm / 0.37 inch



O-0550-0200S

usable for Linvatec

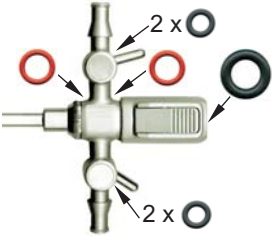

ID - 4,0 mm / 0.16 inch
OD - 7,0 mm / 0.28 inch



O-0400-0150S

ID - 7,65 mm / 0.30 inch
OD - 11,21 mm / 0.44 inch



O-0765-0178R

ID - 9,1 mm / 0.36 inch
OD - 16,2 mm / 0.64 inch



O-0910-0355S

usable for Dyonics



ID - 9,0 mm / 0.35 inch
OD - 16,0 mm / 0.63 inch



1:1

O-Ring
O-0900-0350S

ID - 3,5 mm / 0.14 inch
OD - 4,5 mm / 0.18 inch



O-0350-0050S



usable for Stryker



ID - 11,3 mm / 0.44 inch
OD - 16,1 mm / 0.63 inch



1:1

O-Ring
O-1130-0240S

ID 21,2 mm / 0.83 inch
OD 24,0 mm / 0.94 inch



O-2120-0140R



Verres Needle



Verres Needle - Typ ST
LVW-102-XXX
Verres High Flow Needle - Typ ST
LVH-102-XXX



Verres Needle - Typ WO
LVW-002-XXX
Verres High Flow Needle - Typ WO
LVH-002-XXX

The logo for DANmed, featuring the word "DAN" in a bold, blue, sans-serif font with a slight 3D effect, followed by "med" in a smaller, italicized, blue, sans-serif font.

DANNORITZER Medizintechnik GmbH & Co. KG

Sattlerstr. 25
D-78532 Tuttlingen

Tel.: 0049 (0) 74 61 - 96 239-0

www.danmed.com

mail@danrepair.de